

# Pony Club



## Eventing Rulebook 2024

---

## THE USPC PLEDGE

*As a Member of the United States Pony Club, I stand for the best in sportsmanship as well as in horsemanship. I shall compete for the enjoyment of the game well played and take winning or losing in stride, remembering that without good manners and good temper, sport loses its cause for being. I shall endeavor to maintain the best tradition of the ancient and noble skill of horsemanship, always treating my mount with consideration due a partner.*

## USPC MISSION STATEMENT

The United States Pony Clubs, Inc. is an educational organization which builds the foundations of teamwork and sportsmanship through riding, mounted sports, care of horses and ponies, while developing and enhancing leadership, confidence, responsibility, and a sense of community in its youth and adult members.

### Introduction

Originally developed in the cavalries of Europe as a test of the ideal military charger, Eventing has now evolved into an exciting sport attracting interest from all levels of sports enthusiasts. Eventing is a three-phase equestrian sport designed to test the mount and rider's versatility, fitness, and stamina. Each phase (Dressage, Cross-Country, and Show Jumping) addresses certain elements of the all-around mount. Penalties are incurred in each phase and the mount/rider pair with the fewest penalties at the completion of the last phase are deemed the winners.

### Competitions

Competitions start with the Dressage phase. The French term for "training", Dressage is essential to the event mount as it helps to develop the muscular strength, suppleness, obedience, and maneuverability needed in the other two phases. Mount and rider perform a prescribed pattern of movements and are scored on accuracy, obedience, suppleness, and execution. The Dressage phase is the starting point for the remainder of the competition as the score earned here can determine where you finish.

Cross-Country is the second phase of an Eventing competition. The object of this phase is to prove the speed, endurance, and jumping ability of the mount over varied terrain and obstacles. Mounts and riders must be in peak condition to run cross-country well and not incur any time or jumping penalties. The mount must be bold, smart, and obedient and the rider must have knowledge of pace and a good plan to navigate the course. Mounts are asked to jump a variety of obstacles including logs, cabins, drops and banks, gallop through water, and over brush. The entire course is timed and riders who come in within the time allotted with no jump penalties move on with their original Dressage score.

## USPC CORE VALUES

**H**orsemanship with respect to healthcare, nutrition, stable management, handling and riding a mount safely, correctly and with confidence.

**O**rganized teamwork including cooperation, communication, responsibility, leadership, mentoring, teaching and fostering a supportive yet competitive environment.

**R**espect for the mount and self through horsemanship; for land through land conservation; and for others through service and teamwork.

**S**ervice by providing an opportunity for members, parents, and others to support the Pony Club program locally, regionally and nationally through volunteerism.

**E**ducation at an individual pace to achieve personal goals and expand knowledge through teaching others.

The final phase of an Eventing competition is the Show Jumping phase. While similar to a traditional Show Jumping course the purpose of Eventing show jumping is entirely different. This phase is designed to demonstrate that, after a test of endurance, the mount has retained suppleness, energy, and obedience to the rider. The objective is to leave all the obstacles up and finish the course in the allowed time. A double clear round here adds no penalties to the pair's Dressage score. The mount and rider combination with the lowest total score after Show Jumping is the winner.

### Eventing in Pony Club

Eventing in Pony Club is very similar to Eventing at USEA competitions with the exception of being part of a team. The ridden competition runs exactly like a regular event but with the Horse Management component is added in as well. Riders compete on teams of three or four riders and a stable manager. Members have the opportunity to qualify for USPC national Championships every year by completing their regional Eventing rally and a USEA recognized Horse Trial at their chosen level. Pony Club also offers many awards for excellence in Eventing.

## © 2024 The United States Pony Clubs, Inc. (USPC)

4041 Iron Works Parkway, Lexington, Kentucky 40511-8462 • (859) 254-7669 • Fax (859) 233-4652  
Copying permitted for internal use only by members and volunteers of The United States Pony Clubs

# Table of Contents

## SECTION I: USPC Uniform

### Officiation Rules

Article 1—Rally Definition .....	1
Article 2—Governing Rules .....	1
Article 3—Responsibility .....	1
Article 4—Legal Liability .....	1
Article 5—Member Participation and Eligibility .....	2
Article 6—Member in Good Standing .....	2
Article 7—Code of Conduct Expectations .....	2
Article 8—Substances and Weapons .....	2
Article 9—Mounts .....	3
Article 10—Substitution of Mounts .....	3
Article 11—Sharing of Mounts .....	3
Article 12—Veterinary Care and Medications .....	3
Article 13—Cruelty to and Abuse of a Mount .....	3
Article 14—Dangerous Riding .....	4
Article 15—Safety .....	4
Article 16—Heat Related Information .....	5
Article 17—Concussion and Return to Play .....	6
Article 18—Unauthorized and Permitted Assistance .....	6
Article 19—Excused .....	6
Article 20—Elimination .....	7
Article 21—Disqualification .....	7

## SECTION II: General Regulations

### Chapter 1—Team Composition

Article 22—Team Formation .....	8
Article 23—Team Configuration .....	8
Article 24—Team Captains .....	8
Article 25—Stable Managers .....	8
Article 26—Mount Specifications .....	8
Article 27—Chaperones/Emergency Contacts .....	8
Article 28—Coaches and Coaching .....	9

### Chapter 2—Competition Levels and Divisions

Article 29—Competition Levels .....	9
Article 30—Competition Divisions .....	9
Article 31—Championships Divisions—Minimum Age and Certifications .....	9
Article 32—Championships Eligibility Process .....	10
Article 33—Eligibility Requirements for C-3/B/A Certi- fied Members .....	10
Article 34—Exceptions to Competition Eligibility Requirements for Championships .....	10

### Chapter 3—Presentation of Competitor and Mount

Article 35—Competitor Identification .....	10
Article 36—Competitor Attire .....	11
Article 37—Bits, Saddlery and Equipment .....	12
Article 38—Competitor and Horse Inspections .....	13

## SECTION III: Competition

Article 39—Competition Format .....	15
Article 40—Competition Schedule .....	15

### Chapter 1—Exercising and Access to the Course

Article 41—Exercising/Warm-Up .....	15
Article 42—Access to Courses and Arenas .....	16

### Chapter 2—Dressage Test

Article 43—Dressage Test Rules .....	16
Article 44—Dressage Arena .....	17
Article 45—Scoring Dressage .....	17

### Chapter 3—Cross-Country (Endurance) Test

Article 46—Cross-Country Test Rules .....	17
Article 47—Cross-Country Courses .....	19
Article 48—Cross-Country Obstacles .....	20
Article 49—Cross-Country Definitions of Faults .....	21
Article 50—Vet Check after Cross-Country .....	21
Article 51—Scoring Cross-Country .....	22

### Chapter 4—Jumping Test

Article 52—Jumping Test Rules .....	23
Article 53—Arena and Course .....	24
Article 54—Jumping Test Obstacles .....	25
Article 55—Jumping Test Definitions of Faults .....	26
Article 56—Scoring of Jumping Test .....	27

## SECTION IV: Scoring

Article 57—Points and Penalties .....	29
Article 58—Inquiries, Protests, and Appeals .....	29
Article 59—Scoring of Excused .....	30
Article 60—Scoring of Elimination .....	30
Article 61—Scoring of Disqualification .....	30
Article 62—Team Scoring .....	31
Article 63—Individual Scoring .....	31
Article 64—Posting of Scores .....	31
Article 65—Placing of Teams .....	31

## SECTION V: Officiation

Article 66—Rally Organizer .....	33
Article 67—Technical Delegate (TD) .....	33
Article 68—Discipline Ground Jury .....	34
Article 69—President of the Discipline Ground Jury ... (PGJ) .....	34
Article 70—Championships Overall Ground Jury ...	34
Article 71—Horse Management Judges .....	34
Article 72—Chief Horse Management Judge (CHMJ) .....	35
Article 73—Course Designer .....	35
Article 74—Additional Judges .....	35
Article 75—Inspection Panel .....	35
Article 76—Veterinarians .....	35
Article 77—Chief Scorekeeper .....	35

# Table of Contents

---

Article 78—Required Medical Personnel .....35  
Article 79—Safety Coordinator .....36

## SECTION VI: Eventing

### Appendices

Appendix I: Mounted Competition Scoring Inquiry/  
Protest/Appeal Form .....37  
Appendix II: Heat Illness and Heat Index Chart .....39  
Appendix III: Chaperone and Emergency Contact  
Information .....40  
Appendix IV: Junior/Senior Team Formation.....43  
Appendix V: USPC Eventing Rally TD's Report .....44  
Appendix VI: Eventing Coaching Guidelines Form ..47  
Appendix VII: Eventing Yellow (Warning) Card.....48

Appendix VIII: Specifications for Horse Trials .....49  
Appendix IX: Dressage Saddlery: Permitted Bits.....50  
Appendix X: Dressage Saddlery: Permitted  
Nosebands .....54  
Appendix XI: Dressage Arenas .....55  
Appendix XII: Examples of Obstacles Composed of  
Several Elements .....56  
Appendix XIII: Examples of Run-Outs and Circles ....57

### Resource List

- USPC website [www.ponyclub.org](http://www.ponyclub.org)
- USPC Eventing website [eventing.ponyclub.org](http://eventing.ponyclub.org)
- USEF website [www.usef.org](http://www.usef.org)
- USEA website [www.useventing.com](http://www.useventing.com)
- Discover Eventing website [www.discovereventing.com](http://www.discovereventing.com)

**Reminder:** This is a new Rulebook for 2024. Additions, deletions and changes have been made since the last rulebook was issued. Be sure to read the entire publication carefully so you will be aware of all the rules for the upcoming rally season.

*This rulebook should be kept in a 3-ring binder to allow for addition of revisions and new instructional sections. Do not remove pages from your rulebook; be sure to make copies of all forms and charts before writing on them.*

These rules are based on copyrighted Rules of the U.S. Equestrian Federation and are printed with the permission of the USEF, which neither sponsors nor is responsible for their publication or implementation at any United States Pony Club event.

# SECTION I: USPC Uniform Officiation Rules

---

## Article 1—Rally Definition

Pony Club rallies are team competitions, whether competing unmounted or mounted. All mounted rallies (standard and modified) must include riding and Horse Management competitions. Mounted rallies may run within the framework of a local or recognized show. A rally may take place all in one day or may span several days.

This rulebook is intended to establish standards for United States Pony Clubs (USPC) rallies. Organizers of competitions should work with their regional supervisors (RS) to offer the levels and divisions that they feel are appropriate for their local needs. It is the responsibility of the organizer and RS to offer the appropriate standard or modified rallies and divisions for their members wishing to become eligible for Championships.

Regions may host more than one rally per discipline in the same year. In modified rallies and divisions, organizers and RSs may make rule allowances based on the competitor's needs. Competitors aiming for Championships must strictly follow all attire and equipment specifications. Organizers must outline any rule adjustments in the entry information. Criteria for standard and modified rallies are listed below.

### Standard Rallies

Standard rallies are always preferred. These rallies specifically follow all the rules outlined in the discipline rulebooks including utilizing a Chief Horse Management Judge (CHMJ) from the approved CHMJ list on the USPC website, and any other specified licensed officials. Certain divisions of Championships require the member to attend a standard rally.

### Modified Rallies

Modified rallies do not **explicitly** follow the discipline rulebooks and generally occur because of limited resources. Attendance of a modified rally makes some members eligible for the modified divisions of Championships.

Each year, regions should host rallies and are encouraged to work cooperatively with other regions to host joint rallies as appropriate. At all levels, organizers are encouraged to keep rallies simple and inexpensive. Local and regional rallies are team competitions involving club/centers from only one region. Interregional rallies are team competitions between two or more regions.

If an individual's region does not offer a rally in the desired discipline, they may earn eligibility in another region upon obtaining approval from the RS in both regions.

Rally competitions **are normally held in a team format**, but sometimes members compete as individuals based on the needs of the hosting group. In all rallies, teams should be recognized for their achievements in the competition. In mounted rallies, team/competitor placings will be based on a combination of their riding scores and their Horse Management scores. Separate Horse Management awards are often given for the team/individual with the lowest Horse Management penalties.

## Article 2—Governing Rules

With regards to standard rallies, this rulebook is a precise specification of rules that must be followed. For modified rallies/divisions/competitors, this rulebook should be viewed as a guide that can be adjusted by the rally organizer/RS to best meet the needs of the region. Modifications should be listed in the rally entry information. Additional governing documents for all rallies are the following:

- Annual Discipline Newsletters
- USPC Horse Management Handbook (current edition)
- Official Amendments and Clarifications from USPC
- Appropriate parent organization rulebooks (i.e. USEF, APA). If the rally is being run in conjunction with a recognized event, the parent organization rulebook will supersede this rulebook. If the rally is not being run in conjunction with a recognized event, then this rulebook is to be followed.

Since rules cannot provide for every eventuality (unforeseen or exceptional circumstance), it is the obligation of the discipline ground jury to make decisions in a sporting spirit and to follow as closely as possible the intention of these rules. If there is an inconsistency, the discipline rulebook takes precedence over the Horse Management Handbook.

These rules are based on copyrighted rules of the U.S. Equestrian Federation (USEF) and are printed with the permission of USEF, which neither sponsors nor is responsible for their publication or implementation at any USPC event.

## Article 3—Responsibility

All competitors are ultimately responsible for knowing these rules and complying with them. The appointment of an official, whether or not provided for in these rules, does not absolve the competitor from such responsibility.

## Article 4—Legal Liability

Neither the USPC, host club/center/region(s), the organizer, competition officials, staff, nor any other person acting on behalf of the organizer, shall be held liable for any loss, damage, accident, injury or illness to competitors, mounts or to any other person or property whatsoever.

# SECTION I: USPC Uniform Officiation Rules

---

## Article 5—Member Participation and Eligibility

### Participation in Rallies:

At local, regional, and inter-regional rallies participants

- May be of any age or certification
- Must be a member in good standing, must have paid all local, regional, and national dues, insurance fees
- Membership be on record with the USPC National Office at the time of the rally

Members, parents, and anyone participating in USPC activities must all abide by the applicable Code of Conduct. Members seeking Championships eligibility must meet the eligibility criteria outlined in this document. The member's age as of January 1 shall be the age of record throughout the competition year.

Competitors and mounts are expected to participate in all aspects of the rally including briefings, horse inspections, mounted competition, and Horse Management. For overnight rallies, all mounts are expected to stay on the competition grounds unless the competitor makes other arrangements with the rally organizer prior to the start of the competition.

While competitors are expected to participate fully in the rally, they are encouraged to get out of the barn if their mount is properly cared for with food and water. Based on the competition schedule, competitors may leave the rally grounds during competition hours.

If a mount is removed from the competition grounds without prior consultation with the rally organizer, the competitor may be penalized by the ground jury.

### Championships Competitor Age and Certification:

Each discipline/division has minimum age and certification requirement for participation in Championships. Championships competitors must meet the age requirement based on January 1 of the Championships' competition year. They must have competed at the minimum or higher certification level at a standard or modified rally. Any standard rallies should base their division entry status on the competitor's age for the following year and all rallies should take into account planned advancements in certification level.

District commissioners (DCs) and center administrators (CAs) are responsible for the eligibility of competitors and mounts at all rallies. It is the responsibility of DCs/CAs and club/center primary instructors to see that

- Mounts and riders are entered in rallies at the appropriate level
- To make all competitors aware of health requirements i.e., Coggins, immunizations and state health certificates with valid dates,
- To see that entry forms are complete and submitted to the rally secretary on time.

- All Pony Club members in their jurisdiction have access to a copy of the current USPC discipline rulebook, current USPC Horse Management Handbook (HMH), current USPC discipline annual newsletter(s) and any other relevant information from the USPC discipline committees or the organizer of a specific rally where they will be competing.

## Article 6—Member in Good Standing

(Policy 1002) Members are considered in good standing if they are current with all dues and fees owed the registered club/riding center program, region, **USPC, and have met all compliance requirements.**

## Article 7—Code of Conduct Expectations

The officials of the competition may immediately suspend or expel any individual from the competition upon consulting with the discipline ground jury **for anyone not conforming to the Code of Conduct.**

DCs, CAs, RSs, rally organizers, officials and judges must be familiar with, and enforce, the Participating Member and Adult Code of Conduct.

### Participating Member Code of Conduct

The United States Pony Clubs, Inc. is proud of its reputation for good sportsmanship, horsemanship, teamwork and well-behaved members. The USPC expects appropriate behavior from all members, parents and others participating in any USPC activity. Inappropriate behavior may include, but is not limited to: possession, use or distribution of any illegal drugs or alcohol; profanity, vulgar language or gestures; harassment (i.e., using words or actions that intimidate, threaten or persecute others before, during or following USPC activities); failure to follow rules; cheating; and abusing a mount.

### Adult Code of Conduct

The United States Pony Clubs, Inc. is proud of its reputation for good sportsmanship, horsemanship, teamwork and well-behaved members. It expects no less from the parents, guardians, adult family members or others who volunteer for the organization. The USPC expects appropriate behavior when participating in any Pony Club activity. Inappropriate behavior may include, but not be limited to: profanity, vulgar language or gestures; harassment (for example: using words or actions that intimidate, threaten or persecute others before, during or following any Pony Club activity); failure to follow rules; cheating; or abusive behavior.

*"I understand that USPC activities operate under the governance of USPC and are subject to all applicable USPC By-laws, Policies, Rules and Regulations. I understand that I have access to these By-laws, Policies, Rules and Regulations and that it is my responsibility to read them. I agree to adhere to these By-laws, Policies, Rules, Regulations and this Code of Conduct. Failure to do so may, at the discretion of USPC, result in being restricted from attendance or participation in Pony Club activities."*

# SECTION I: USPC Uniform Officiation Rules

---

## Article 8—Substances and Weapons

(Policy 0500) In the interest in the safety and welfare of all, it is the policy of the Board of Governors, during any Pony Club activities, to prohibit the inappropriate or illegal use of any substance, including but not limited to drugs or alcohol, by anyone participating in any manner. Weapons of any kind are forbidden.

## Article 9—Mounts

(Policy 0840) Mounts used at a regional or interregional rally should be the participant's regular USPC mount, and accustomed to being handled by its rider without adult supervision. A participant may use a different mount only with the advance permission of the DC/CA and RS.

Ownership of a mount is not a prerequisite for membership in USPC. The responsibility for obtaining a suitable mount for mounted activities rests with the **individual** or parents/guardians of the individual member.

Per USPC Policy 0840 suitable mounts are defined as follows:

1. Stallions are not considered suitable mounts.
2. Mounts must be serviceably sound, in good overall health and in condition for the activity in question.
3. Mounts must be appropriate for the certification level of the rider and must be at a level of training to participate safely in the activity.
4. Except as noted below, mounts must be at least five (5) years of age in order to participate in USPC competitive, instructional, and recreational programs and activities. In establishing the age of mounts, the first year is considered to be January 1 following the date of foaling.
5. Members holding a riding certification of C-1 and above may participate in all USPC activities on an appropriate mount at least four (4) years of age.

A mount must be excused from any activity if in the opinion of the instructor, examiner, or appropriate authority, it is unsafe either to its rider or to other riders or mounts.

## Article 10—Substitution of Mounts

For all mounted rallies (except Tetrathlon), mount and rider become eligible for Championships as a team. Therefore, a competitor must enter Championships only on the mount on which they earned eligibility.

In extraordinary circumstances, after becoming eligible for Championships, a substitute mount may be requested via the online application a minimum of five days before Championships move-in by the RS. The panel reviews each application to verify the substitute mount meets the same mount eligibility requirements as the original entry. Refer to the Mount Substitution application found on the USPC website.

- Mounted Games and Polocrosse teams may bring a spare mount for the competition. See Section II and III for additional information (Discipline Rulebooks).
- Tetrathlon mounts need not have participated in a regional rally prior to Championships participation.

## Article 11—Sharing of Mounts

In some disciplines and in some competitions, the sharing of mounts may be allowed. At regional rallies, the rally organizer in consultation with the RS may allow for the sharing of mounts by competitors. For Championships, requests for shared mounts must be submitted using the Mount Substitution online application found on the USPC website. Each request will be reviewed on a case-by-case basis, for approval or denial. Determination of shared mounts must take into consideration the discipline, competition schedule, and suitability of mount. The welfare of the mount will be the highest priority in this situation and all competitors must agree that if the horse management, judges, technical delegate (TD)/steward, or organizers onsite feel that the health of the mount is in jeopardy at any time that they may be removed from the rest of the riding portion of the competition.

## Article 12—Veterinary Care and Medications

(Policy 0860 and 0860 P.1) To promote the safety and welfare of Pony Club members, their mounts, and provide fair and unbiased competitions, the Policy of the Board of Governors is that all mounts in USPC sponsored activities be serviceably sound and healthy. The definition of serviceably sound may vary based on the mount's duties and competition level.

Medications may be administered to mounts, provided their use does not create an unfair advantage or allow an unfit mount to participate as determined by the rally officials.

It is the owner/rider's responsibility, in coordination with a veterinarian, to determine what medication(s) are appropriate.

Competitors participating in USPC rallies held in conjunction with other competitions may be subject to medication rules of other organizations in addition to those of USPC.

### Additional requirements and information:

- Any mount receiving medication for chronic conditions must have medications listed on their stall card.
- Mounts requiring medications for acute conditions treated by a veterinarian, the competitor/parent, or owner, must coordinate with responsible party for the activity or Horse Management staff prior to administration.
- Medication is defined as any substance that is not water, salt, electrolytes, or a supplement and is not considered a normal foodstuff.

## Article 13—Cruelty to and Abuse of a Mount

Cruelty to or the abuse of a mount present on the grounds of any competition is forbidden and renders the offender subject to

# SECTION I: USPC Uniform Officiation Rules

---

penalty. The organizing committee **will** bar violators from further participation for the remainder of the competition.

Any action(s) against a mount by a competitor or other person, which are deemed excessive by a judge, steward, TD or competition veterinarian, in the competition ring or anywhere on the competition grounds may be punished by official warning, elimination, or other sanctions which may be deemed appropriate by the organizing committee. Such action(s) may include, but are not limited to excessive use of the whip or spurs.

USPC, judges, stewards, or TDs may appoint a veterinarian to inspect any animal on competition grounds or entered to compete. Refusal to submit an animal for examination by an authorized veterinarian after notification shall constitute a violation.

The following are included under the words cruelty and abuse but are not limited thereto:

1. Abuse. Any act or series of actions that, in the opinion of a judge, TD, steward, member of the discipline ground jury or other rally official can clearly and without doubt be defined as abuse of mounts shall be penalized by disqualification. Such acts include, but are not limited to:
  - Riding an exhausted mount.
  - Excessive pressing of a tired mount.
  - Excessive use of whip and/or spurs, and/or bit.
  - Striking a mount in front of the shoulder.
  - Riding an obviously lame mount.
2. Rapping. All rapping (poling) is forbidden.
3. Whip. The use of the whip must be for a good reason, at an appropriate time, in the right place, and with appropriate severity.
  - Reason—The whip must only be used either as an aid to encourage the mount forward, or as a reprimand. It must never be used to vent a rider's temper. Such use is always excessive.
  - Time—As an aid, the only appropriate time is when a mount is reluctant to go forward under normal aids of the seat and legs. As a reprimand, the only appropriate time is immediately after a mount has been disobedient, e.g., napping or refusing. The whip should not be used after elimination. The whip should not be used after a mount has jumped the last fence on a course or completed the last obstacle.
  - Place—As an aid to go forward, the whip may be used down the shoulder or behind the rider's leg. As a reprimand, it must only be used behind the rider's leg. It must never be used overhand, e.g., a whip in the right hand being used on the left flank. The use of a whip on a mount's head, neck, etc., is always excessive use.
  - Severity—As a reprimand only, a mount may be hit hard. However, it should never be hit more than two times for any one incident. If a mount is marked by the whip, e.g., the skin is broken, its use is excessive.

4. End of the Reins (Trail only) - The use of the end of the reins must be for a good reason, at an appropriate time, in the right place, and with appropriate severity.

- Reason—The end of the reins must only be used either as an aid to encourage the mount forward, or as a reprimand. It must never be used to vent a rider's temper. Such use is always excessive.
  - Time—As an aid, the only appropriate time is when a mount is reluctant to go forward under normal aids of the seat and legs. As a reprimand, the only appropriate time is immediately after a mount has been disobedient, e.g., napping or refusing. The end of the reins should not be used after elimination.
  - Place—As an aid to go forward, the end of the reins may be used down the shoulder or behind the rider's leg. As a reprimand, it must only be used behind the rider's leg. It must never be used overhand, e.g., the end of the reins in the right hand being used on the left flank. The use of the end of the reins on a mount's head, neck, etc., is always excessive use.
  - Severity—As a reprimand only, a mount may be hit hard. However, it should never be hit more than two times for any one incident. If a mount is marked by the end of the reins, e.g., the skin is broken, its use is excessive.
5. Spurs—Spurs must not be used to reprimand a mount. Such use is always excessive, as is any use that results in a mount's skin being broken.
6. Bit—The bit must never be used to reprimand a mount. Any such use is always excessive.
7. Reporting—Officials must report such actions as soon as possible to the discipline ground jury, supported where possible by statements from witnesses.
- Discipline ground jury—if such actions are reported, the discipline ground jury shall decide if there is a case to be answered. If an individual member of the discipline ground jury observes such actions, they are obliged to disqualify the competitor forthwith on their own authority. There is no appeal against a discipline ground jury's decision in a case of abuse.

## Article 14—Dangerous Riding

1. Any competitor who rides in such a way as to constitute a hazard to the safety or wellbeing of the competitor, mount, other competitors, their mounts, spectators, or others will be penalized accordingly.
2. Any act or series of actions that in the opinion of the judge, TD, steward, member of the discipline ground jury can be defined as dangerous riding shall be penalized at the discretion of the discipline ground jury.
3. If such actions are reported, the discipline ground jury shall decide if there is a case to be answered. There is no appeal against a discipline ground jury decision.



# SECTION I: USPC Uniform Officiation Rules

---

## Article 15—Safety

(Policy 0800) USPC is committed to safety while recognizing that equestrian activities are inherently dangerous. The USPC Safety Handbook is an excellent resource for making safety a priority at all rallies and Pony Club functions. This dedication to safety extends to requiring certain equipment be utilized during Pony Club activities and include:

1. Protective Headgear (Policy 0810): USPC requires members participating in mounted and some unmounted activities to wear a properly fitted equestrian helmet, securely fastened, containing certification that it meets the criteria established by the following international or national safety bodies:
  - ASTM F1163 with SEI Mark (North America)
  - SNELL Memorial Foundation E2016 or E2021
  - AS/NZS 3838 with SAI Global Mark
  - PAS 015 with BSI Kitemark.
2. Safety Vest/Body Protector (Policy 0830): USPC requires members to wear a properly fitted equestrian body protector when jumping cross-country or solid obstacles during any activity sponsored by the USPC, its regions, registered clubs or riding center programs. A member may wear a body protector at their discretion for any mounted activity.
3. Medical Armbands and Bracelets (Policy 0820 and 0820P):
  - USPC requires that members participating in any USPC affiliated mounted or unmounted activity, must wear either a medical armband or medical bracelet while participating in the activity. The member may choose which one to wear.
  - Medical armbands must include a current completed copy of the individual's USPC or USEA Medical Card. It must be worn on the upper arm. If the member has small arms, they may safety pin the armband to their upper sleeve. (Armbands are available for purchase from Shop Pony Club.)
  - Medical bracelets must visibly list these six items on them: name, date of birth, contact information, known allergies, current medications, and existing medical conditions. More information is acceptable, but these six items are required to be on the bracelet
  - All officials on site at the USPC mounted or unmounted activity are encouraged to work with the competitors to remind them of this requirement.
  - Any member at a USPC affiliated mounted or unmounted activity\* found not wearing either a medical armband or medical bracelet must be removed from the activity until the member conforms to the policy requirement.

*\*Tetrathlon competitors will not be required to wear them while actually shooting or swimming but must have them visible and next to them for these activities and must wear them at all other times.*

4. Unmounted Footwear: When working in the barn or near mounts unmounted footwear must meet all the following criteria:

- Thick-soled, shoes/boots (short or tall)
- Cover the ankle
- In good condition
- Made of leather or synthetic materials
- Entirely closed
- Securely fastened
- Well-fitted to foot
- Sturdy construction (e.g., Ugg-type boots do not meet this requirement)

Examples: paddock/jodphur boots, rubber riding boots, rain boots/wellies, western boots.

5. Smoking: In the interest of barn safety, it is strictly forbidden for anyone to smoke in or around barn and stable areas.

## Article 16—Heat-Related Information

(Policy 0900): USPC requires all Pony Club volunteers in a leadership position within Pony Club and especially anyone involved directly with mounted or unmounted lessons or activities to complete the Centers for Disease Control and Prevention (CDC) heat illness training module.

At all USPC activities, rally officials must consider the:

- Temperature and humidity using the "Heat Index Chart" (Appendix II).
- Time of day and season of activity.
- Level of exertion necessary for participation in the activity.

The Heat Index (HI) or "Apparent Temperature" is the temperature the body feels when heat and humidity are combined. This reduces the amount of evaporation of sweat from the body and outdoor exercise becomes dangerous even for those in good shape. Please refer to Appendix II.

Steps to prevent heat-related illness include:

- Providing unlimited cool water for consumption in ALL areas, especially riding areas.
- Make water breaks mandatory.
- Do not depend on thirst as an indicator of the need for water.
- Avoid the hottest part of the day if this is an option.
- Consider shortening the length/level or exertion of the activity.

During rallies, the discipline ground jury (overall ground jury at Championships) is responsible for monitoring the Heat Index and taking appropriate action as necessary. Those actions could include, but are not limited to:

# SECTION I: USPC Uniform Officiation Rules

---

- Waiving of coats/jackets
- Banning of coats/jackets
- Altering of schedule

Any official can and should bring a potentially dangerous heat situation to the attention of the president of the ground jury. If coats/jackets are waived or banned the following processes should be followed.

## Waived Coats/Jackets

When the temperature and humidity are recorded in the danger zone, removal of coats during warm up is mandatory.

If the rider wants to put their coat/jacket on for their competition round, then they may leave their neckwear and helmet cover on during warm up.

If the rider does not want to put their coat/jacket on for their competition round, then they must remove all neckwear and their helmet cover during warm up.

## Additional Information

- When coats are waived, the competitors must be turned out per Competition Attire (including coats/jackets) unless they choose to compete wearing Basic Riding Attire.
- Riders must wear a collared shirt with long or short sleeves if they are not wearing a jacket.
- T-shirts are not permitted.

Competitors must also remove neckwear and helmet covers on vented helmets if they do not wish to wear their jackets for their competitive ride.

## Banned Coats/Jackets

When temperature and humidity are recorded in the danger zone and based on the decision of the discipline ground jury (overall ground jury at Championships) coats/jackets may be banned for the safety of competitors. If coats/jackets are banned then competitors must remove coats/jackets, neckwear and helmet covers for turnout inspections, warm up and for competition rounds.

## Heat-Related Illness Return To Play

A member believed by a leader, coach, parent or official of a USPC unmounted or mounted activity or competition to be suffering from heat illness shall be removed from play at that time and given appropriate treatment before being allowed to return to play.

## Article 17—Concussion and Return to Play

(Policy 0900): USPC requires all Pony Club volunteers in a leadership position within Pony Club and especially anyone involved directly with mounted or unmounted lessons or activities to complete the concussion training module.

A member believed by a leader, coach, parent or official to have sustained a concussion during a USPC unmounted or mounted activity must be referred to medical personnel. Medical personnel in conjunction with rally officials and organizers will determine if a written release is required for the member to return to the competition.

## Article 18—Unauthorized and Permitted Assistance

1. Unauthorized Assistance: Unauthorized assistance is help and/or assistance during the competition from anyone other than other competitors, HMJs, and rally officials. Unauthorized assistance can occur in person or through the use of electronic communication, unless allowed by the specific discipline rulebook (e.g., coaches in certain situations)
2. If, in the opinion of a member of the ground jury, unauthorized assistance has been received by a competitor, that competitor may be eliminated from that phase of the rally, or in extreme cases, disqualified from the competition. The discipline ground jury makes the final decision. There is no appeal.
3. Permitted Assistance:
  - Adults may aid in the unloading of mounts and carrying of heavy gear into the stable area upon arrival, after which non-competitors must immediately leave the area.
  - After a fall of a competitor or dismount, they may be assisted to catch their mount, to adjust their saddlery, to remount, or to be handed any part of their saddlery or equipment, including whip, while they are dismounted or after they have remounted. Helmets must be replaced, and retention harnesses refastened before riders may remount.
  - A competitor may receive clarification of jumping penalties from an obstacle judge, e.g., after jumping a flag at a corner, the judge may clarify whether it was a run-out or not.
  - If bodily harm to mount and/or rider is imminent, assistance from anyone (official or otherwise), without concern for penalties, is expected. Time permitting, the situation should be brought to the attention of an official. If immediate intervention is necessary, then an official will be notified as soon as possible concerning the situation.
  - If a mount is ill or injured, the owner/agent of the mount will be called in to discuss care.
  - Exception for loose mounts in Mounted Games only: In Mounted Games, a loose mount may be caught by any competitor or official already in the arena when the loose mount is behind Lines A and C. However, only the mount's rider may enter the playing area to catch it.

# SECTION I: USPC Uniform Officiation Rules

---

## Article 19—Excused

1. May also be called a “Technical Elimination”
2. To grant permission to, or request that a competitor leave the phase/round/game due to circumstances outside of the competitor’s control (e.g., illness of rider, illness or lameness of mount)
3. Decided by
  - Inspection panel at mount inspection
  - Judge
  - Discipline ground jury
4. May not ride; therefore, will not receive any riding score during the excuse, but
  - May request a lameness recheck
  - Rider may request to compete in following phases/rounds/games after if illness passes.
  - Both the mount and rider shall stay on rally grounds (unless the mount is transported for medical reasons) and continue to participate with the team and continue to be scored in Horse Management.
  - If ill, mount will be moved to another area, if possible.

## Article 20—Elimination

- Elimination means to exclude a competitor or mount, for cause, from judging consideration in a class/phase. Competitor not scored in a class due to a mistake (e.g., use of illegal equipment, violation of the rules of phase/rounds/ games.)
- After elimination, the discipline ground jury in consultation with the organizer, may allow participation in subsequent phases/rounds/games.
- Determined by judge or discipline ground jury.
- Refer to scoring of penalties for additional discipline specific reasons for elimination.

## Article 21—Disqualification

Disqualification is a punishment for misconduct arising from a deliberate attempt to contravene the rules and regulations of USPC applied at the discretion of the discipline ground jury. Any disqualified competitor and their mount may not take further part in the competition including in Horse Management.

Reasons for disqualification include, but are not limited to:

- abusive or unsportsmanlike conduct
- obscene or inappropriate language
- the inappropriate or illegal use of drugs (other than those prescribed by a physician), alcohol, or tobacco (Article 8)
- rude and disruptive behavior
- cheating
- cruelty (Article 13)
- rough or dangerous riding
- knowingly riding a lame, sick, or exhausted mount
- misuse of equine medications (Article 12)

If a rally official identifies a competitor behaving in a way that could lead to disqualification, that official may issue a written warning to the competitor using Appendix VII, a Yellow Card. If the rally official believes the Yellow Card should have penalties attached to it, or that the competitor should be disqualified, they must refer the situation to the discipline ground jury.

The discipline ground jury shall investigate the situation and interview the competitor(s) and all applicable witnesses before making a final decision on penalty points.

If a Yellow Card with penalty points is assigned to a competitor, it may not exceed a 50% impact on the associated phase/round score if related to a single phase/ round, or a 50% impact on the overall score. There is no appeal against a discipline ground jury decision on issuing a penalty points or disqualifying a competitor.

Refer to Section V for additional discipline specific reasons for disqualification and scoring (Discipline Rulebooks).

# SECTION II: General Regulations

---

## Chapter 1—Team Composition

### Article 22—Team Formation

#### Regional Rallies:

The district commissioner (DC) or center administrator (CA) of local clubs/centers are responsible for club/center team formation at regional rallies. A team made up of members from one local club/center remains the ideal and is always the goal. Scramble teams made up of members from multiple clubs/centers are also accepted. The DCs/CAs of the clubs/ centers involved may assist the rally organizer in forming scramble teams. RSs (RSs) may have final determination.

#### Championships:

The RS (or individual designated by the RS) is responsible for marking in the database all members who have earned eligibility for Championships regardless of their intent to participate.

As members register, the RS is responsible for putting together the teams based on the offered Championships divisions. A team made up of members at the same competition level, and from one region remains the ideal and is always the goal.

Once registration closes, RSs lose the ability to merge teams. Based on the final competition numbers, the discipline secretary shall make the final adjustments to teams and scrambling of individuals without a full team. Requests for preferred teammates may be submitted but are not guaranteed.

### Article 23—Team Configuration

1. Teams shall normally consist of 3 or 4 riding members and an unmounted stable manager. One member of the team will be designated as team captain. A competitor may serve as both the stable manager and team captain at the same time. The team members can all belong to one or possibly multiple divisions as determined by the rally organizer.
2. At the organizer's discretion, there may be an alternative configuration of teams based on entries.
3. The requirement of an unmounted stable manager may be waived at regional rallies by the RS.

### Article 24—Team Captains

Each team entered in the competition shall have one member designated as team captain who shall act as spokesperson for the team. Only the team captain may lodge a protest on behalf of any team member (Appendix I).

The team captain is responsible for all communications between the team and rally officials. The team captain is the official spokesperson for the team. In the event of an inquiry, protest or appeal, the captain represents the team. The competitor involved should accompany the captain. It is the responsibility of team captains to ensure that their team members follow all

rules and regulations of the competition and to transmit to them any changes or additional instructions provided by rally officials. Any withdrawal of a team member must be reported to the TD.

Teams losing a team captain to illness must designate another team member to take over the responsibilities of captain. If the original captain returns, they will resume the responsibilities of captain.

### Article 25—Stable Managers

A non-riding stable manager is required at Championships. At regional rallies, non-riding stable managers are highly recommended. Riding stable managers may be allowed at the discretion of the RS. The stable manager works closely with the team captain to coordinate preparations for the rally, in addition to assisting in keeping the team organized and on schedule during the competition.

### Article 26—Mount Specifications

All mounts entered in a USPC Eventing rally must meet the requirements outlined in Article 9.

In addition for Eventing competitions, mounts may not compete in more than one Eventing competition held on the same day(s). Competitors may not share mounts in Eventing competitions held on the same day(s).

### Article 27—Chaperones/Emergency Contacts

All competitors below the age of majority must have an official chaperone, 21 years of age or older, listed with rally organizers. All competitors above the age of majority must have an emergency contact, who is available during the competition, listed with the rally organizers. Please review the following criteria for chaperones and emergency contacts.

1. Chaperones:
  - Any team with a competitor under the age of majority must have an official chaperone, 21 years of age or older, designated for the competition.
  - The chaperone will act as the contact person for that team and must always be on the rally grounds during competition hours.
  - Several individuals may share one team's chaperone duties, but only one name will be listed as the official chaperone. All persons sharing this duty should be made aware of this name and answer to it.
  - The chaperone should serve as a volunteer for the competition but may not assume coaching duties.
  - Anyone serving as team chaperone must understand and agree to the duties outlined in Appendix III.
2. Emergency Contacts:
  - Any competitor above the age of majority must submit a completed Emergency Contact Form (Appendix III) with their entry.

# SECTION II: General Regulations

- Those listed as an emergency contact must be available by phone during the competition.

## Article 28—Coaches and Coaching

Eventing coaches are allowed, but not mandatory for all rallies. There may be one or more coaches (may not also serve as chaperone). The presence of a coach at Eventing rally is to promote safety, good sportsmanship and good horsemanship in the warm-up area and the competition ring. Coaches are expected to help any Pony Club competitor who asks for assistance or whose coach is not present in the warm up area.

- Competitors in a rally may also coach other competitors, providing they meet the following criteria:
- Must be 18 years of age as of January 1 of the competition year.
- No scheduling changes will be made to accommodate the coaches/competitors ride times.
- Competitor's responsibilities and mount's care always takes precedence over coaching duties.

### Eventing Coaches:

- Must read, understand, sign and return a Coaches Form with the team entry (Appendix V).
- Must know the USPC Eventing rules, especially regarding unauthorized assistance; see Article 18, 43.13, 46.7, 52.3D, 60.C. Access to the team is limited and they may not enter the stable area except during authorized visiting times.
- At Championship competitions, coaches must attend the opening competitor briefing, and any coaches briefings.

## Chapter 2—Competition Levels and Divisions

### Article 29—Competition Levels

At regional rallies a rider may ride at any level offered, in which they feel their mount would be able to perform. Below are the most commonly offered levels at Eventing rally; most are United States Eventing Association competition levels.

- Greenie
- Starter (USEA Level)
- Beginner Novice (USEA Level)
- Novice (USEA Level)
- Training (USEA Level)
- Modified (USEA Level)

### Article 30—Competition Divisions

Competition divisions differ from competition levels in that competitors may be separated into divisions based on age and/or other parameters. A competitor's age is determined by their age as of January 1 on the year of competition. See Article 5 for more details on age minimums.

Junior Divisions—Up to and including 17 years of age

Senior Divisions—18 years of age and above

**Note:** Rally divisions can be combined based on entry numbers and approval of the organizer and RS. Junior competitors can always compete up a division as a senior to fill out a team. Senior competitors can never compete down in a junior division. Before combining junior and senior aged competitors on the same team, rally organizers must get the written approval of the Junior competitor and their parent/legal guardian (Appendix IV).

### Article 31—Championships Divisions—Minimum Age and Certifications

Competitors seeking Championships eligibility must meet the age parameters and minimum certifications for the offered Championships divisions. Age is as of January 1 of the competition year, and there are no age and no certification exceptions to the below requirements. See Article 5 for more details on age and certification minimums.

#### Modified Championships Divisions

Division	Level	Age	Certification
Junior	Beginner Novice	10-17	D-2 EV, HSE
Senior	Beginner Novice	18+	
Junior	Novice	10-17	
Senior	Novice	18+	
Junior	Training	10-17	
Senior	Training	18+	

#### Standard Championships Divisions

Division	Level	Age	Certification
Junior	Beginner Novice	12-17	C-1 EV, HSE
Senior	Beginner Novice	18+	
Junior	Novice	12-17	
Senior	Novice	18+	
Junior	Training	12-17	
Senior	Training	18+	
Junior	Modified	14-17	
Senior	Modified	18+	

Stable managers must meet the minimum age criteria of their division and be a D-2 HM for modified divisions and a D-3 HM for all other divisions.

Note: Championship divisions may be combined based on entry numbers and approval from Vice President of Activities and the overall organizer.

# SECTION II: General Regulations

---

## Article 32—Championships Eligibility Process

Each individual Pony Club member who desires to compete at Championships must compete in a regional rally and be judged at the minimum HM level and same competition level in which they intend to compete at Championships. This constitutes the “individual eligibility” of the competitor.

Members wanting to become eligible for Championships must meet the below division criteria.

### Modified Beginner Novice and Novice Levels

A rider must complete a standard Eventing rally and one USEA recognized event at or above the competition level, both with numerical scores.

OR

If no standard Eventing rally is available, complete a modified Eventing rally and one USEA recognized event at or above the competition level, both with numerical scores.

OR

If no modified Eventing rally is available, complete two USEA recognized events at or above the competition level, both with numerical scores. And complete a mounted standard rally as a rider at a D-2 or above HM certification level and prove Vet Box knowledge.

### Standard Beginner Novice and Novice Levels

A rider must complete (with numerical scores) a standard Eventing rally and one USEA recognized event at or above the competition level with no more than 20 XC jumping penalty points total between the two competitions.

OR

If no standard Eventing rally is available, complete (with numerical scores) two USEA recognized events at or above the competition level with no more than 20 XC jumping penalty points between the two competitions. And complete a mounted standard rally as a rider at a C-1 or above HM certification level and prove Vet Box knowledge.

### Modified Training Level

A rider must complete a standard Eventing rally and two USEA recognized events at or above the competition level, all with numerical scores.

OR

If no standard Eventing rally is available, complete a modified Eventing rally and two USEA recognized events at or above the competition level with numerical scores.

OR

If no modified Eventing rally is available, complete three USEA recognized events at or above the competition level, all with numerical scores. And complete a mounted standard rally as a rider at a D-2 or above HM certification level and prove Vet Box knowledge.

### Standard Training and Modified Levels

A rider must complete (with numerical scores) a standard Eventing rally and two USEA recognized events at or above the competition level with no more than 20 XC jumping penalty points between the three competitions.

OR

If no standard Eventing rally is available, complete (with numerical scores) three USEA recognized events at or above the competition level with no more than 20 XC jumping penalty points between the three competitions. And complete a mounted standard rally as a rider at a C-1 or above HM certification level and prove Vet Box knowledge.

## Article 33—Eligibility Requirements for C-3/B/A Certified Members

Certified C-3/B/A members may become eligible for Beginner Novice and Novice Championships by completing two USEA Recognized HTs in the twelve months preceding Championships. At least one of these competitions must have no cross-country jumping penalties, with the other having no more than 20 cross-country jumping penalties.

Certified C-3/B/A members may become eligible for Training and Modified Championships by completing three USEA Recognized HTs in the eighteen months preceding Championships. At least two of these competitions must have no cross-country jumping penalties, with the other having no more than 20 cross-country jumping penalties.

## Article 34—Exceptions to Competition Eligibility Requirements for Championships

Exceptions to the competition eligibility process are occasionally granted. There are no exceptions to minimum age and certification requirements. The process for requesting an exception is outlined on the USPC website. All requests for exceptions must come from the RS to the review panel using the online application found on the USPC website.

## Chapter 3—Presentation of Competitor and Mount

### Article 35—Competitor Identification

Identification numbers (pinnies, bridle numbers, etc.) must be worn in a prominent manner on the competitor or mount, as designated by rally officials.

# SECTION II: General Regulations

Pinnies must always be worn in the barn area. Competitor nametags must always be worn, except when mounted.

## Article 36—Competitor Attire

Each participant is responsible for organizing their own attire and equipment which must meet all safety requirements outlined in Article 15. Competitors should be neat and clean with inappropriate jewelry not permitted; see Horse Management Handbook for specifications. Participants must wear a medical armband or bracelet as specified in Article 15.3. A Pony Club pin must be worn at all times unless otherwise stated by rally officials. Felt can be placed behind pins using the below designations:

Certification	Felt Color
A.....	Royal Blue
H-A.....	Orange
B.....	Red
H-B.....	Brown
C-3.....	White
C-1 and C-2.....	Green
D-1 through D-3.....	Yellow

Depending on the activity, different attire expectations exist. The different situations and attire expectations are listed below.

1. General Barn Attire—Attire must be safe, free of rips and tears. Shirts must have sleeves to the point of the shoulder or longer and appropriate unmounted footwear.
2. Horse Inspection (Jog Outs)—Attire must be safe, appropriate, neat and clean. It must include a helmet (meeting USPC Helmet Policy, Article 15.1), and appropriate unmounted footwear (Article 15.4). Workmanlike and discipline appropriate attire including a tucked in collared shirt with pants/skirt/mid-length shorts/riding pants. If the pants/skirt has belt loops, a belt is required. Blue jeans are not acceptable for english discipline horse inspection attire.
3. Turnout Inspection and first round of competition— All competitors must present at turnout inspection in appropriate competition attire, including a jacket. Competitors may ride their message test without a jacket, wearing a long or short sleeve shirt tucked in, with a collar, and without neckwear. Any competitors not seeking Championships eligibility may turnout and compete in appropriate competition attire or in basic riding attire as detailed below. Attire requirements may be adjusted based on excessive heat as detailed in Article 15. In inclement weather, competitors will be allowed to wear a helmet cover and a transparent or conservative colored raincoat

## 4. Competition Attire for Eventing:

### Turnout Inspection and Dressage Attire

#### Required

Helmet—May be any color, with accents that meets USPC Helmet Policy (Article 15.1).

Hair—Hair should be neatly secured (away from the eyes) and may not cover competitor number.

Shirt—Shirt of any color and design with a collar and sleeves, tucked into pants.

Neckwear—For Dressage, stock tie, choker, tie or integrated stand-up collar. Traditional stock ties require a stock pin, pre-tied stock ties may be worn with or without stock pin.

Coat/Jackets/Vest—Short riding coat of a single color (including tweeds and pinstripes) with accents.

Pants—Jodhpur or breeches. White or light color.

Belt—If pants have belt loops, belts are required.

Footwear—Conventional type of riding footwear, that covers the ankles (short or tall) with a heel. Tall black, brown, or other dark hue, dress or field boots, or jodhpur/paddock boots with matching full grain smooth leather leg piece or leather-like material are allowed. Accents of a different color are permitted.

#### Permitted

Gloves—Dark colors, tan, beige, or white.

Safety/Protective Vests—Any color.

Spurs—Spurs must be of smooth metal. If there is a shank it must not be longer than 4 cm (1 9/16 inches, measured from the boot to the end of the spur) and must point only towards the rear. If the shank is curved, the spurs must be worn only with the shank directed downwards. Metal or plastic spurs with round hard plastic or metal knobs “Impulse spurs” and “Dummy spurs” with no shank are allowed. Spurs with rowels are allowed in warm-up only. If they are used, rowels must be free to rotate and the rowel must be round and smooth (no tines allowed). Spurs capable of wounding a mount are forbidden.

#### Not Permitted

Tail coats, pastel and dark colored breeches, full chaps and/or suede half-chaps

### Cross-Country Attire

#### Required

Helmet—Any color meeting USPC Helmet Policy (Article 15.1).

Hair—Hair should be neatly secured (away from the eyes) and may not cover competitor number.

Shirt—Shirt of any color and design with a collar and sleeves, tucked into pants.

Protective Vests— Per Article 15.2, any color.

## SECTION II: General Regulations

---

Pants—Jodhpurs or Breeches, any color.

Belt—If pants have belt loops, belts are required.

Footwear—Conventional type of riding footwear, that covers the ankles (short or tall) with a heel. Tall black, brown, or other dark hue, dress or field boots, or jodhpur/paddock boots with matching full grain smooth leather leg piece or leather-like material are allowed. Accents of a different color are permitted.

### Permitted

Gloves—Any type, color

Spurs—As described in Dressage Attire.

### Show Jumping Attire

### Required

Helmet—May be any color, with accents that meets USPC Helmet Policy (Article 15.1).

Hair—Hair should be neatly secured (away from the eyes) and may not cover competitor number.

Shirt—Shirt of any color and design with a collar and sleeves, tucked into pants.

Neckwear—Stock and pin, choker, tie or integrated stand-up collar.

Coat/Jacket—Short riding coat of a single color (including tweeds and pinstripes) with accents. Competitors may ride their jumping round without a jacket, wearing a long or short sleeve shirt tucked in, with a collar, and without neckwear.

Pants—Jodhpurs or breeches, must be light in color or white.

Belt—If pants have belt loops, belts are required.

Footwear—Conventional type of riding footwear, that covers the ankles (short or tall) with a heel. Tall black, brown, or other dark hue, dress or field boots, or jodhpur/paddock boots with matching full grain smooth leather leg piece or leather-like material are allowed. Accents of a different color are permitted.

### Permitted

Gloves—Dark color, tan, beige or white.

Safety/Protective Vests—Any color.

Spurs—As described in Dressage Attire.

### Not Permitted

Tail coats, pastel and dark colored breeches, full chaps and/or suede half-chaps

5. Basic Riding Attire for Eventing:

### Unrated and D-1

### Required

Helmet—Any color meeting USPC Helmet Policy (Article 15.1).

Hair—Hair should be neatly secured (away from the eyes) and

may not cover competitor number.

Shirt—Collared shirt with sleeves and tucked in.

Pants—Long pants.

Footwear—Conventional type of riding footwear, that covers the ankles (short or tall) with a heel.

### Permitted

Belt—Any type/color.

Gloves—Any type/color.

Half-chaps—Any type/color.

Safety/Protective Vests—Any color.

Spurs—As described in Dressage Attire.

### D-2 and up

Rider must be in safe, neat, and clean attire.

### Required

Helmet—Any color meeting USPC Helmet Policy (Article 15.1).

Hair—Hair should be neatly secured and away from the eyes.

Shirt—Collared shirt with sleeves and tucked in.

Pants—Breeches, jodhpurs (with garters and/or pant clips) or riding pants.

Belt—If pants have belt loops, belts are required.

Footwear—Conventional type of riding footwear, short or tall, with a heel that covers the ankles are required.

### Permitted

Gloves—Any type/color.

Half-chaps—Any type/color.

Safety/Protective Vests—Any color.

Spurs—As described in Dressage Attire.

### Article 37—Bits, Saddlery and Equipment

The following information is the most basic description of allowable bits, saddles and equipment for Eventing. Final determination of permitted and prohibited bits, saddlery and equipment may require referencing the USEF Eventing Rulebook and Annex 1 which are both available on the USEF website for the most up to date information.

All competitors seeking eligibility must turnout and compete per the specific bits, saddlery and equipment rules outlined in this rulebook and the USEF Eventing Rulebook and Annex 1. Any competitors not pursuing Championships eligibility may request bits, saddlery and equipment allowances from the rally organizer and RS. (i.e., kimberwicke bits, grazing reins, standing martingale, etc.)

The following restrictions begin upon arrival on the competition grounds and continue throughout the duration of the rally. The



## SECTION II: General Regulations

---

following are compulsory: an English type saddle and a permitted bridle.

### 1. Exercise Arenas

- A. Running martingales with rein stops, boots, bandages, fly shields, and nose covers are permitted. Side reins are permitted only while longeing an unmounted mount. Other martingales, any form of gadget (such as a bearing, running or balancing reins, etc.) and any form of blinkers, are forbidden, under penalty of disqualification.
- B. One whip no longer than 120cm (47.2 in.) including lash may be carried when riding on the flat at any time. A standard longe whip may be used when longeing a mount. An adjustable-length whip may not be carried by a mounted rider.

### 2. Dressage Test

#### A. Bits and Nosebands

A rounded snaffle bit made of metal, leather, rubber or plastic material is permitted for all tests, and may be covered with rubber/latex. The reins must be attached to the bit. It may have a cavesson noseband, dropped noseband, crossed noseband, or flash noseband. The noseband must be made entirely of leather or leather like material, except for a small disk of sheepskin, which may be used in the intersection of the two leather straps of a crossed noseband. All bits must be properly fitted and consistent with its intended use.

#### B. Saddlery

An english type saddle is required.

#### C. Extra Equipment

- 1. One whip no longer than 110cm (43.3 in.) may be carried during the Dressage test except in USEF/USEA/USPC Championships divisions. An adjustable length whip may not be carried by a mounted rider.
- 2. A breast plate may be used.
- 3. A neck strap or pommel strap may be used. The strap must be made primarily of leather.
- 4. Ear hoods are permitted for all tests and may also provide noise reduction. However, ear hoods must not cover the mount's eyes and ear plugs are not permitted. The ear hoods should be discreet in color and design.

5. Nose nets are permitted under the following conditions:

- A. The entry must be accompanied by a letter signed by the mount's veterinarian on letterhead, stating that the mount has been diagnosed with head shaking syndrome and that the mount's condition is improved with the use of a nose net.
- B. The nose net must be made of a transparent material and cover only the top half of the muzzle, not the bit or the mount's mouth.

6. Martingales, bit guards, any kind of gadgets (such as bearing, side, running or balancing reins, etc.), reins with any loops or hand attachments, any kind of boots or leg bandages and any form of blinkers, including earmuffs, earplugs, hoods, and seat covers are, under penalty of elimination, strictly forbidden.

### 3. Cross-Country test and Jumping test

#### A. Bits

An english type bridle (including Gags) or a hackamore.

#### B. Saddlery

English type saddle.

#### C. Extra Equipment

- 1. One whip no longer than 75cm (30") may be carried in the Cross-Country and/or Jumping test, or while jumping any obstacle before these tests. It must not be weighted at the end. An adjustable-length whip may not be carried by a mounted rider.
- 2. Only unrestricted running martingales with rein stops or irish martingales are allowed.
- 3. Reins must be free of any loops or hand attachments and must be attached to the bit(s) or directly to the bridle. Exception: u-shaped bit converters may be used so that a bit designed for use with two reins may be controlled with a single rein.
- 4. In the interest of safety, the stirrup iron and stirrup leathers must hang free from the bar of the saddle and outside the flap. There must be no other restrictions or attachments of any kind.
- 5. Any form of blinkers are forbidden.

**NOTE:** Final determination of permitted and prohibited bits, saddlery and equipment may require referencing the USEF Eventing Rulebook and Annex 1 which are both available on the USEF website for the most up to date information.

# SECTION II: General Regulations

---

## Article 38—Competitor and Horse Inspections

Mounds must be well groomed. Braiding is optional, as long as it does not interfere with the competitor's responsibilities to their mount. Braids must be removed prior to Turnback. Mounds need not be shod, but their feet are expected to be in good condition and not in need of any attention upon arrival at the rally. The discipline ground jury may exclude unsafe, inappropriate, lame, otherwise unsound or exhausted mounds from the competition at any time during the rally.

### Examinations of Mount and Rider Required at Eventing Rally:

#### 1. Horse Inspections (Jog Outs):

Horse inspections are required at standard rallies and Championships and recommended for all rallies. Before the beginning of competition, the mounds must be examined in hand, for soundness, by an Inspection Panel. All mounds shall be serviceably sound. Should the soundness of a mound be questioned, the matter shall be reported immediately to the TD, who shall request an inspection of the mound by the veterinarian. In the absence of the veterinarian, the judges or TD shall determine the ability of the mound to compete. All decisions by the veterinarian, TD or judges regarding the soundness of a mound and its ability to compete are final.

- It is recommended that the president of the ground jury be present at the initial inspection.
- The discipline ground jury may, at its discretion, at any time, have any mound jog for soundness before the inspection panel.

#### 2. Turnout Inspection:

Approximately 45-60 minutes prior to the first ride of the competition, all competitors will report to their turnout inspection. The rally organizer will designate turnout inspection times. At turnout inspection, competitors must wear the appropriate attire for their discipline and present their mound with all the equipment they will wear/use in the first ride of the competition. More details about turnout inspection requirements are listed in the HMM.

#### 3. Safety Check:

Safety checks occur before each subsequent ride. Failure to present for a safety check prior to a ride is cause for elimination. More details about safety check expectations are listed in the HMM.

#### 4. The Vet Box: (see HMM for full details about the Vet Box)

At the completion of Cross-County, after pulling up, each competitor must immediately go to the vet box and report to Horse Management or the veterinarian. Riders eliminated, disqualified, or who retire on the course must also report to the vet box.

The vet box is a clinical evaluation of the mound's condition following the cross-country phase of the competition. While in the vet box the temperature, pulse, and respiration may be taken in addition to a clinical evaluation of a mound's condition. After the veterinarian has finished with the mound and given any needed directions, the competitor or a teammate may begin cool out procedures. The veterinarian makes at least one more check (usually within 10-15 minutes) before permitting the mound to return to the stable for the final cool out.

# SECTION III: Competition

---

## Article 39—Competition Format

USPC Eventing rallies are competitions where teams compete against each other in both riding and Horse Management competition. USPC Eventing rally rules and procedures are based on USEF and USEA rules. Refer to the USEF or USEA website for additional clarification: [www.usef.org](http://www.usef.org), [www.useventing.com](http://www.useventing.com).

## Article 40—Competition Schedule

The following is a basic schedule for an Eventing rally. Please note that while the cross-country phase and jumping phase may be reversed in order, the Dressage phase is always ridden first.

1. Briefing—Competitors are responsible for knowing all information from all official briefings whether present or absent. At least one representative from each team must be present at every official briefing.
2. Horse Inspection (formerly jog out)—Required at standard rallies and recommended for all rallies. Opportunity to inspect mounts for soundness.
3. Turnout Inspection—Each rider reports at their assigned time and location for Turnout Inspection with their mount. Riders must present for Turnout Inspection in the exact attire and with all the equipment they will wear/use in the first riding phase of the competition.
4. Dressage ride
5. Safety Check—At all USPC competitions, prior to each and every riding phase, a complete safety check of each competitor's attire, mount, and equipment must take place.
6. Cross-Country ride
7. Vet Box—Riders will report to the Vet Box at the completion of their cross-country ride to cool out their mount. They will be supervised by Horse Management staff while in the vet box.
8. Safety Check
9. Jumping test ride
10. Turnback—Following riding phases, there may be an official check (turnback) of the mount, tack and equipment used for that phase.
11. Awards

## Chapter 1-Exercising and Access to the Course

### Article 41—Exercising/Warm-Up

1. Restrictions on Exercising Mounts
  - A. It is forbidden, under penalty of disqualification, for anyone other than the competitor who will ride the mount in the competition to exercise the mount during the competition. This period of restriction begins from

the time of arrival on the rally grounds and extends until departure from the rally grounds.

- B. Riding close to cross-country obstacles, or riding in the Dressage or jumping arenas prior to the actual competition is forbidden, unless specifically authorized by either the discipline ground jury, under penalty of disqualification. The Dressage arena may not be used after it has been prepared for the competition and closed by the organizer. The jumping arena may not be used after it has been prepared for the competition and closed by the organizer. The organizer shall report any violation of this rule to the president of the ground jury.
2. Exercise Areas
    - A. During regular rally hours, areas suitable for the general exercise of mounts must be made available and must be open. The organizing committee must inform competitors of the areas that are available for this purpose. Mounts competing may only be exercised in such designated areas or in the practice areas for Dressage and jumping. An additional area for longeing may be available at the discretion of the organizer after consultation with mount management.
    - B. A Dressage exercising area must be provided at a convenient distance from the competition arena. A practice Dressage arena should, if possible, be placed at the disposal of the competitors.
    - C. An exercising area with jumps must be provided at a convenient distance from the start of cross-country and from the jumping arena. The exercising area for show jumping must include at least two spread (oxers) and two vertical adjustable practice fences. The exercising area for cross-country must include at least three adjustable fences (including at least one oxer) and at least one solid cross-country type obstacle is recommended. Where space or materials are limited, and with the permission of the TD, either or both areas may contain at least three adjustable obstacles including at least one oxer. These obstacles must be marked with red and white flags.
    - D. The only practice fences that competitors may jump are those flagged by the organizer. No part of the obstacle may be held by anyone while a mount is jumping. These fences may not be raised more than 4 inches above the maximum height permitted for the competition in progress, (or about to begin), nor may the spread exceed the maximum permitted. Ground lines may be placed directly under or up to one meter (3'3") in front of the obstacle. They may not be placed even slightly on the landing side. The upper ends of crossed poles must always be supported by cups.
    - E. Any violation of the above rules is subject to disqualification at the discretion of the discipline ground jury.

# SECTION III: Competition

---

- F. In cases where there is limited space for schooling/warm-up, the number of mounts allowed to warm-up at one time may be restricted by rally organizers.
- 3. Stewards: One or more warm-up stewards, who are not Horse Management judges, must be present in the warm up areas when they are open as declared by the organizer, to ensure that the rules regarding exercising and warming up are obeyed. If tack needs major adjustment after the safety check, the competitor must return to a Horse Management judge for assistance.

## Article 42—Access to Courses and Arenas

### 1. Cross-Country course

- A. Before the course has been opened to competitors, it is forbidden, under penalty of disqualification, to inspect the obstacles or the course without the permission of the organizers, at the discretion of the discipline ground jury.
- B. The cross-country course will be open for inspection to all competitors, no later than 3:00 PM the day before the competition starts at a USEF event. All obstacles, flags and markers that have to be observed by competitors shall be exactly in position when the course is shown to the competitors. In the case of multiple courses running on the same track, a sign will be posted at obstacle(s) to be changed, indicating such change(s). This shall include changes to flags as well as to obstacles. Thereafter, they may not be moved or altered by competitors, under penalty of disqualification.
- C. After the course has been officially opened to the competitors, they are allowed to revisit the course and examine the obstacles during the hours of daylight.

### 2. Jumping course

The course for the jumping test will be opened to competitors not less than 30 minutes before the start of the jumping test, and at convenient intermissions during the jumping test. Competitors on foot will be admitted to the arena by permission of the discipline ground jury. An announcement must also be made over the public address system. Unless permission has been given by the discipline ground jury, it is forbidden, under penalty of disqualification, for competitors to enter the arena on foot once the test has started.

## Chapter 2—Dressage Test

### Article 43—Dressage Test Rules

- 1. All tests must be carried out from memory, and all movements must follow in the order laid down in the test.
- 2. After the signal has been given, the competitor must enter the arena at A within 45 seconds.
- 3. A test begins with the entry at A and ends after the salute at the end of the test, as soon as the mount moves forward.

Any incidents before the beginning or after the end of the test have no effect on the marks. The competitor should leave the arena in the way prescribed in the text of the test.

- 4. Competitors must take the reins in one hand at the salute.
- 5. When a movement must be carried out at a certain point of the arena, it should be done at the moment when the competitor's body is above this point.
- 6. The use of the voice in any way whatsoever or clicking the tongue once or repeatedly is a serious fault involving the deduction of at least two marks from those that would otherwise have been awarded for the movement where this occurred.
- 7. In case of marked lameness, the judge at C will inform the competitor that they are eliminated. There is no appeal against this decision.
- 8. A mount leaving the arena completely, with all four feet, between the time of entry and the final salute, will be eliminated.
- 9. Any resistance that prevents the continuation of the test longer than 20 seconds will be penalized by elimination.
- 10. When a competitor makes an "error of course" (takes the wrong turn, omits a movement, etc.) the judge at C warns them by sounding the signal. The judge shows them, if necessary, the point at which they must take up the test again and the next movement to be executed, then leaves them to continue by themselves. However, in some cases when, although the competitor makes an "error of course," the sounding of the signal would unnecessarily impede the fluency of the performance (for instance if a competitor makes a transition at V instead of K), it is up to the judge at C to decide whether to sound the bell or not. However, if the signal is not sounded at an error of test in which the movement is repeated and the error occurs again, only one error is recorded.
- 11. When a competitor makes an "error of the test" (trots rising instead of sitting, does not take the reins in one hand at the salute, etc.), they must be penalized as for an "error of course."
- 12. In principle, a competitor is not allowed to repeat a movement of the test unless the judge at C decides on an error of course and sounds the signal. If the competitor has started the execution of a movement and tries to do the same movement again, the judge(s) must consider the first movement shown only and at the same time penalize for an error of course.
- 13. Any outside intervention by voice, signs, etc., is considered unauthorized assistance. A competitor receiving unauthorized assistance will be eliminated, at the discretion of either the discipline ground jury.
- 14. The judge at C may stop a test and/or allow a competitor to restart a test from the beginning or from any appropriate

# SECTION III: Competition

---

point in the test if, at their discretion, some unusual circumstance has occurred to interrupt a test.

## Article 44—Dressage Arena

1. The arena size will be specified by the Dressage tests to be ridden (small arena or standard arena). The measurements are for the interior of the enclosure. The arena should be separated from the public by a distance of not less than 15 meters. The enclosure itself should consist of a low fence, about 30 cm (12 inches) high. It is recommended that the entrance at A be a minimum of 2 meters and a maximum of 4 meters wide. The part of the fence at A should be easy to remove, to allow access, or may be left open. The fence should be such to prevent the mount's hooves from entering.
2. The letters should be placed outside the enclosure, about 50 cm (20 inches) from the fence. The letter A should be a sufficient distance from the entrance to allow unobstructed entry. It is desirable to place a special marker on the fence itself, level with and in addition to the letter concerned.
3. The judge is placed 5 meters (16 feet) from the end of the arena opposite the letter C. An enclosure (tent, trailer) should be provided and it should be raised at least 0.5 meters (20 inches) above the ground to give the judge a good view of the arena.
4. For diagrams of small and standard arena, see Appendix XI.

## Article 45—Scoring Dressage

1. Judges will award good marks from 0-10 for each movement and for each collective mark, with 0 being the lowest mark and 10 being the highest. All half marks from 0.5-9.5 may be used both for movements and collective marks, at the discretion of the judge, and scores given must be recorded with a decimal (e.g., as 6.0 instead of 6).
2. Errors of course or test will be penalized as follows:
  - 1st Time by 2 points
  - 2nd Time by 4 additional points
  - Elimination
3. All of the following are considered errors, and two points will be deducted per error, but they are not cumulative and will not result in elimination.
  - Entering the space around the arena with a whip (when whips are forbidden) or with boots or bandages on the mount's legs or with a discrepancy in dress (e.g. lack of gloves).
  - Entering the arena with a whip (when they are forbidden) or with boots or bandages on before the discrepancy has been noticed, the judge at C stops the competitor and if needed and possible, an assistant may enter the arena to remove the item(s). The competitor then continues the test, either starting from the beginning (from inside the fence) or from the movement where they were stopped.

The marks given before they were stopped are not changed.

- Entering the arena before the sound of the signal
  - Not entering the arena within 45 seconds after the bell, but within 90 seconds; gives the two-point penalty (not cumulative, not counted as an error) for over 45 seconds but less than 90 seconds.
4. In the case of a fall of a mount and/or competitor, the competitor will not be eliminated. They will be penalized by the effect of the fall on the execution of the movement concerned and in the collective marks.
  5. After elimination, a competitor may continue their performance to the end. The marks will be awarded in the ordinary way.
  6. Additional Reasons for Elimination:
    - A. An elimination is left to the discretion of the either the discipline ground jury in the following cases:
      - Receiving unauthorized assistance
      - Performing the test in incorrect dress
    - B. Elimination must be applied in the following cases:
      - Competitor not entering the competition arena within 90 seconds after the signal. Except where a valid reason thereto has been provided to the judge at C (valid reason such as losing a shoe, etc.)
      - Performing a test with improper saddlery (illegal whip, spurs)
      - Marked lameness
      - Leaving the arena between the time of the entry and the final salute
      - Resistance
  7. Calculating Dressage Penalties
    - A. The percentage of maximum possible good marks obtainable is then calculated by dividing the total good marks received (minus any error of test) by the maximum possible good marks obtainable, then multiplying by 100 and rounding the result to two decimal digits.
    - B. In order to convert percentage into penalty points, the percentage must be subtracted from 100. The result is the score in penalty points for the test.

## Chapter 3—Cross-Country (Endurance) Test

### Article 46—Cross-Country Test Rules

For questions not answered in this rulebook, or for clarification, please refer to the USEF rules for the cross-country test.

# SECTION III: Competition

---

## 1. Starting:

- A. Competitors at the start must be under the control of a starter. The mount does not have to stand absolutely immobile, but the competitor must not get any advantage from a flying start. Each competitor should be given reasonable warning before the time they are due to start, but it is the competitor's responsibility to ensure that they start at the correct time.
- B. In order to simplify the task of the starter, an enclosure five meters by five meters (16 by 16 feet) will be built at the start, with an open front and a gap in one or both sides through which mounts will both enter and start. Each competitor must start from within the enclosure, but is at liberty to move around the enclosure as they please. An attendant may lead the mount into the enclosure, and may hold the mount until the signal to start is given. From that instant, the competitor is considered to be on the course and no further assistance may be given.
- C. If a competitor starts early, their time will be recorded from the moment they cross the start line and five seconds will be added as penalty. In the event of a false start in conjunction with speed faults, five seconds will be subtracted from the overall time as a penalty.
- D. If a competitor is not ready to start at their correct time, they may be allowed, at the discretion of the starter, to start when they are ready, subject to the following conditions:
  - A late competitor will not be permitted to start if there is any risk of interfering with the subsequent competitor.
  - Their starting time will be recorded as if they had started at the correct time.

## 2. Time:

- A. Timing—Time is counted from the instant the starter gives the signal until the instant when the mount reaches the finishing line. Time is counted in whole seconds, parts of a second counting as the next whole second (e.g. 30.25 seconds is recorded as 31 seconds). When an electronic timer is used for the start, the starter must cut the beam with their hand.
- B. Time Limit—For all levels, the time limit is twice the optimum time
- C. Optimum Time—The distance divided by the designated speed gives the optimum time. A competitor exceeding the optimum time will be penalized in accordance with Article 51—Scoring cross-country. Time is counted in whole seconds, parts of a second counting as the next whole second (e.g. 30.25 seconds is recorded as 31 seconds.)
- D. Speed Fault Time—For all divisions, the distance chosen divided by the faster designated speed gives

the speed fault time. Completing the course in less than the optimum time is not penalized up to the speed fault time. Completing the course in less than the speed fault time will be penalized in accordance with Article 51.

## 3. Errors of Course:

All compulsory passages and all obstacles, including all elements and/or options, must be passed or jumped in order, under penalty of elimination. All red and white flags must be respected wherever they occur on the course, under penalty of elimination. Re-taking an obstacle already jumped is forbidden, under penalty of elimination.

4. Pace and Dismounting: Between the start and finish, competitors are free to choose their own pace. They must be mounted to pass all red and white boundary flags. Dismounting as a result of attempting an obstacle, whether voluntary or not, is penalized as a fall. Elsewhere on the course, competitors may dismount without incurring a fault, other than possible penalties for exceeding the optimum time.

## 5. Overtaking:

- A. Any competitor who is about to be overtaken by a following competitor must quickly clear the way. Any competitor overtaking another competitor must do so only at a safe and suitable place.
- B. When the leading competitor is before an obstacle and about to be overtaken, they must follow the directions of the officials. When the leading competitor is committed to jumping an obstacle, the following competitor may jump that obstacle only in such a way that will cause no inconvenience or danger for either.
- C. The penalty for willful obstruction of an overtaking competitor, failure to follow the instructions of the officials, or causing danger to another competitor is elimination at the discretion of the either the discipline or overall ground jury.

## 6. Competitor in Difficulty:

If, in attempting to negotiate an obstacle, a mount should be trapped in such a way that it is unable to proceed without assistance, the mount shall be retired from competition and the score posted as a mandatory retirement.

## 7. Stopping Competitors:

If any part of an obstacle is obstructed by a competitor in difficulty, if any obstacle has been dismantled to release a fallen mount, if an obstacle has been broken and has not yet been rebuilt, or in any similar circumstances, subsequent competitors must be halted.

- A. In such a case, an official should be posted in the path of the oncoming competitor. They shall wave a red flag, which indicates that the competitor must stop. Failure to stop is penalized by elimination at the discretion of the discipline ground jury.

# SECTION III: Competition

---

- B. Competitors may be stopped at obstacles or at stopping points on the course.
  - C. The official will stop competitors only upon the instructions of the control center, or during a rapidly developing emergency at their own obstacle.
  - D. The time during which the competitor was stopped, from the moment they pass the stopping point until they re-pass the same point after being given the order to restart, will be recorded. It will be deducted from the total time taken by the competitor to complete the course. It is clearly intended that the time shall be taken as the competitor gallops past the stopping point, not after they halt nor after a start from the halt.
8. Unauthorized and Authorized Assistance Specific to cross-country:
- A. Unauthorized is defined as any intervention, whether solicited or not, with the object of facilitating the task of the competitor or of helping their mount, is considered unauthorized assistance and may result in the elimination of the competitor.
    - 1. In particular, the following are forbidden:
      - Intentionally to join another competitor and to continue the course in company with them;
      - To be followed, preceded or accompanied, on any part of the course by any vehicle, bicycle, pedestrian, or mountman not in the competition;
      - To post friends at certain points to call directions or make signals in passing
      - To have someone at an obstacle to encourage the mount by any means whatsoever;
      - To tamper with the obstacles or any part of the course, including, for instance, flags, indicators, markers, notices, ropes, trees, branches, wire or fences, whether temporary or permanent.
    - 2. Officials or spectators who draw the attention of a competitor to a deviation from the course are giving unauthorized assistance which may result in the elimination of the competitor.
    - 3. Each case of unauthorized assistance will be decided by either the discipline or overall ground jury.
  - B. Authorized Assistance:
    - Headgear or spectacles may be handed to a competitor at any time.
    - A competitor may receive clarification of jumping penalties from an obstacle judge, e.g., after jumping a flag at a corner, the judge may clarify whether it was a run-out or not.
9. After Elimination:
- A competitor eliminated or retired for any reason must leave the course at once and go to the vet box and has no right to continue. If they do not stop at once and it can be established beyond

a reasonable doubt that they should be eliminated or retired, they should be stopped as soon as possible and reported to the discipline ground jury. A competitor must walk their mount off the course either mounted or dismounted. Violators shall be warned or fined up to \$100 (payable to the organizing committee), at the discretion of the discipline ground jury.

## Article 47—Cross-Country Courses

1. Marking of the Course:
  - A. Red or White Boundary Flags—These shall be used to mark the starting and finishing lines, to mark compulsory passages, and to define obstacles. They are placed in such a way that a competitor must leave a red flag on their right and a white flag on their left.
  - B. In cases where courses for two or more levels of competition are marked at the same time, only those flags which form part of the course for the relevant competition are to be considered to be in effect at any one time.
  - C. Yellow Directional Marker: Show the general direction to be taken and to help competitors find their way. Where necessary, they shall be superimposed with the first letter or color of the level. Passing close to them is not obligatory.
2. Numbers and Letters:
  - A. Each obstacle shall be numbered. Obstacles with elements or options shall in addition be lettered (A, B, C, etc.). Each compulsory passage shall be marked with the first letter of the level and numbered consecutively. Numbers and letters shall be painted as follows:
  - B. Modified—orange on a blue background, Training—white on a black background, Novice—black on a white background, Beginner Novice—black on a yellow background.
3. Start and Finish Lines: In addition to the red and white boundary flags, the starting and finishing lines shall also be marked by distinct signs.
4. Distances and Speeds: The distances and the speeds demanded are determined by the intended difficulty of the whole Test. Within the limits shown, course designers may choose the distances and speeds most suitable to the terrain and to the quality and standard of preparation of the competitors.
5. Finishing Lines: The last obstacle on course shall be not less than 25 meters nor more than 75 meters from the finishing line.
6. Plan of the Course:
  - A. Each competitor will be given in advance a plan showing the track of the course.
  - B. The plan must include the following: the position of the start and finish lines, the numbered compulsory passages, the numbered obstacles, the distance, the optimum time, the time limit.

# SECTION III: Competition

---

- C. Simple water crossings shall be flagged at the entrance.
- 7. Spectators should not be in such a position as to obstruct a competitor.

## Article 48—Cross-Country Obstacles

### 1. Definition:

- A. An obstacle is considered if and only if its extremities are marked with a red and white flag or flags and it is numbered.
- B. All significant jumping efforts that the average mount may be expected to attempt to negotiate must be defined as an obstacle or element and flagged, numbered and/or lettered accordingly.

### 2. Obstacles with Elements or Options:

- A. If two or more jumping efforts, sited closely together, are designed as one integral test, they will be designated as “elements” of a single numbered obstacle. Each element will be marked with a different letter (A, B, C, etc.) and must be negotiated in the correct order.
- B. Where two or more jumping efforts are sited so closely together that after a refusal or run out it would be unreasonably difficult to attempt to negotiate the second or subsequent effort without retaking one or more earlier efforts, these jumping efforts must be designated as one numbered obstacle and lettered accordingly.
- C. Where an obstacle may be jumped in one effort but has options involving two or more efforts, each of these options must be lettered as an element.

### 3. Nature of Obstacles:

- A. The obstacles must be fixed and imposing in shape and appearance. When natural obstacles are used, they should, if necessary, be reinforced so that they remain in the same state throughout the test. All reasonable precautions must be taken to prevent the possibility of a competitor being able to pass mounted under an obstacle. Portable fences must be secured to the ground in a way that the fence cannot move.
- B. The cross-country obstacles at which a mount, in falling, is likely to be trapped or to injure itself, must be built in such a way that part of the obstacle can be quickly dismantled and can be quickly rebuilt exactly as before. Such a construction must not in any way detract from the solidity of the obstacle.

### C. Water Crossings:

- 1. In all water crossings, the bottom should be firm and consistent. The maximum depth of the water shall not exceed 35 cm (14”).
- 2. Water at the Beginner Novice Level shall be a straightforward water crossing without obstacles. It shall be flagged at the entrance. The minimum width

of water shall be 5.0 meters (16’5”). If it is necessary to re-vet the banks, the re-vetting shall not exceed 50 cm (1’8”).

- 3. In all water crossings involving obstacles, the minimum distance between obstacles shall be 9 meters (29’3”). In all water-to-water obstacles, there shall be a minimum of 6 meters (19’6”) of water before the obstacle.

- D. Bullfinches must be constructed in such a way that the average mount will be encouraged to jump through it.

### 4. Number of Jumping Efforts:

- A. Within the limits shown in Appendix VIII, the total number of jumping efforts shall be related to the length of the course.
- B. To arrive at the number of jumping efforts, the efforts on the route expected to be taken by the average mount shall be totaled (e.g. corners labeled AB are counted as one effort).
- C. At the BN and Novice levels, water crossings will be flagged and numbered and subject to penalties but will not be counted in the number of jumping efforts.

### 5. Dimensions:

- A. Within the limits shown in Appendix VIII, the dimensions of obstacles should be related to the quality and standard of preparation of the competitors.
- B. The fixed and solid part of an obstacle may not exceed the specified height at any of the points at which a competitor might reasonably attempt to negotiate the obstacle.
- C. At obstacles with spread only (dry or water filled ditch), a guard rail or hedge in front that facilitates jumping is permitted. It may not exceed 50 cm (20 inches) in height. It must be included in the measurement of the spread.
- D. Any roof, or other fixed and solid barrier over an obstacle, must not be less than 3.36 meters (11 feet) above the ground.

### 6. Measurements:

- A. The height of an obstacle is measured from the point where the average mount would take off. The spread of an obstacle is measured from the outside of the rails or other material making up the obstacle.
- B. When the height of an obstacle cannot be clearly defined (natural hedge or brush fence), the height is measured to the fixed and solid part of the obstacle through which a mount cannot pass with impunity.
- C. The drop on the landing side of an obstacle is measured from the highest part of the obstacle to the spot where the average mount would land.



# SECTION III: Competition

---

## Article 49—Cross-Country Definitions of Faults

1. General: Faults (refusals, run-outs, circles and falls) will be penalized unless in the opinion of the responsible judge, they are clearly not connected with the negotiation or attempted negotiation of a numbered obstacle or element for the relevant competition in progress. The negotiation or attempted negotiation of an obstacle commences with the presentation of the mount to the obstacle.
2. Disobediences (Refusals and Run-Outs)
  - A. Refusals.
    1. At obstacles or elements with height (exceeding 30 cm), a mount is considered to have refused if it stops in front of the obstacle to be jumped.
    2. At all other obstacles (i.e., 30 cm or less in height) a stop followed immediately by a standing jump is not penalized, but if the halt is sustained or in any way prolonged, this constitutes a refusal. The mount may step sideways but if it steps back, even with one foot, this is a refusal.
    3. After a refusal, if a competitor redoubles or changes his efforts without success, or if the mount is represented at the obstacle after stepping back and stops or backs again, this is a second refusal, and so on.
  - B. Runouts. A mount is considered to be disobedient if it runs-out, avoids the obstacle or element to be jumped in such a way that it has to be represented. A rider is permitted to change his mind as to where he jumps an obstacle or element at any time without penalty for a run-out, including as a result of a mistake at a previous obstacle or element.
  - C. At an obstacle composed of several elements (A B obstacle), a mount may be disobedient and refuse or run-out only twice in all without incurring elimination.
3. Circles:
  - A. At an obstacle composed of several elements (A, B, C, etc.) a mount will be penalized if it passes around any element, circles or crosses his tracks between elements at any time between first being presented at the obstacle and finally completing the last element.
  - B. After being penalized for a refusal, run-out or circle, a competitor is permitted to cross his original track without penalty in order to make another attempt and may also circle one or more times without penalty, until he again presents his mount at the obstacle.
  - C. At separately numbered obstacles, a competitor may circle between or around them without penalty provided he has not represented his mount at the second or subsequent obstacles.

4. Falls:
  - A. A competitor is considered to have fallen when they are separated from their mount in such a way as to necessitate remounting or vaulting into the saddle.
  - B. A mount is considered to have fallen when at the same time both its shoulder and quarters have touched either the ground or the obstacle and the ground.
  - C. A fall of mount and/or rider will always be penalized when it occurs between the elements of an obstacle composed of several elements (A B C).
5. Additional Attempts at Obstacles Composed of Several Elements: If after a disobedience at an obstacle composed of several elements a competitor wishes to retake any element already jumped in order to complete negotiation of the obstacle, he may do so. However, he is liable to be penalized for any additional fault even if it is at an element previously jumped successfully. If after a disobedience a competitor wishes to pass through flags in the wrong direction in order to retake an element, he may do so without penalty.
6. Willful Delay: A competitor is considered to have willfully delayed his finish if, between the last fence and the finish line, the mount halts, walks, circles, or serpentines. The competitor will be penalized at the discretion of the discipline ground jury.
7. Instructions to Officials: Where there is any doubt as to the correct interpretation of the rules of judging any obstacle, the TD, on the advice of the discipline ground jury, shall approve the instruction to the judges and provide a rough sketch if necessary. And all competitors shall be informed of any such instructions at the briefing, or as soon as possible if later.

## Article 50—Vet Check after Cross-Country

1. Upon completing the course, riders will come to the vet box or to a designated area protected as much as possible from sun and weather and removed from spectators and confusion. A horse management judge and a veterinarian will be on duty. Specific procedures particular to immediately will be reviewed the evening prior to the cross-country phase by the CHMJ after consultation with the veterinarian.
2. Riders disqualified, or who retire on the course, must also report to the vet box.
3. Procedures upon entering the vet box:
  - A. Gradually come to a walk. Report immediately to the veterinarian or horse management judge. Competitors not reporting to horse management staff or the veterinarian in the finish area immediately after the finish of cross-country will be penalized 10 HM points by the CHMJ. This rule allows the veterinarian to keep accurate track of the mounts as they come off the course.

# SECTION III: Competition

---

- B. Stand at the head of, but not in front of, the mount, and allow the veterinarian to take temperature, pulse and respiration. At this time, the competitor should stand quietly, be attentive and observe the veterinarian.
  - C. After the veterinarian has completed the examination of the mount and given any specific directions, attend to mount's primary needs and check for major injuries or distress.
  - D. Remove tack as efficiently as possible, depending upon available help.
  - E. Cooling out should be done appropriately according to the mount's condition and weather (e.g., heat and humidity).
4. Cooling Out Procedure
- A. Examine mount for cuts, abrasions, loose or pulled shoes, etc.
  - B. Walk slowly in a large circle and keep a safe distance from others.
  - C. Sponge mount and scrape to remove sweat and lather.
  - D. Encourage heat loss through evaporation by repeated water baths, continuing to sponge and scrape mount to remove water as it heats up from the body.
  - E. Gradually offer water to mount as it is walked.
  - F. Continue walking, washing and scraping.
  - G. Cover mount appropriately according to the weather (e.g., cold and/or windy).
5. Report to veterinarian when requested for at least one more check, usually in ten minutes. Continue reporting to the vet as instructed until excused. At the discretion of the veterinarian and the CHMJ, riders will be excused to complete the cooling out process and attend to the mount properly in the stable area.
- and Novice).....Elimination
  - First fall of competitor (Training and Modified) .....Elimination
  - First fall of mount ..... Mandatory Retirement
- C. Willful Delay: (Beginner Novice, Novice and Training)
- Between last fence and the finish line ....20 penalties
2. Time and Speed Faults: Time is counted in whole seconds, parts of a second counting as the next whole second (e.g. 30.25 seconds is recorded as 31 seconds.)
- A. Time Faults (Beginner Novice, Novice, Training, and Modified levels):
    - Exceeding optimum time..... 0.4 penalty point/second
    - Exceeding the Time Limit.....Elimination
  - B. Speed Faults (Beginner Novice, Novice and Training Levels):
    - For each second under the Speed Fault Time .....0.4 penalty points/second
3. Vet Box:
- A. Penalty points may be given by the CHMJ for the following infractions:
    - Improper pulling up after the finish .. up to 15 points
    - Improper cooling out..... up to 20 points
    - Distressed mount ..... up to 15 points
    - Not reporting to HMJ..... 10 points
4. Additional Reasons for Elimination:
- A. Elimination is left to the discretion of either the discipline ground jury in the following cases:
    - Willful obstruction of an overtaking competitor, or failure to follow the instructions of the officials while being overtaken.
    - Causing danger to another competitor while overtaking that competitor.
    - Failure to stop when signaled.
    - Unauthorized assistance.
  - B. Elimination must be applied in the following cases:
    - Competing with improper saddlery
    - Error of course not rectified
    - Omission of obstacle or compulsory passage
    - Jumping an obstacle or passing through a compulsory passage in the wrong order
    - Jumping an obstacle in the wrong direction
    - Retaking an obstacle already jumped
5. Calculating Cross-Country penalties
- A. Total any jumping penalties, time penalties or speed

## Article 51—Scoring Cross-Country

1. Faults at Obstacles:
- A. Disobediences:
    - First refusal, run-out or circle .....20 penalties
    - Second refusal, run-out or circle at the same obstacle..... 40 penalties
    - Third refusal, run-out or circle at the same obstacle .....Elimination
    - Fourth penalized disobedience on the entire course at Beginner Novice, Novice, Training, or Modified.....Elimination
  - B. Falls:
    - First fall of competitor in which the competitor lands on their feet and remains standing (Beginner Novice and Novice) .....65 penalties
    - Second fall of competitor (Beginner Novice

# SECTION III: Competition

---

faults from the competitors cross-country ride and add to the existing penalty score.

## Chapter 4—Jumping Test

### Article 52—Jumping Test Rules

#### 1. Start:

The round starts when the competitor crosses for the first time in the correct direction the starting line after the bell has been rung. The time awarded to the competitor starts running either upon crossing the starting line or upon expiration of the 45th second of the countdown, whichever occurs first.

#### 2. Time:

##### A. Timing:

- The time of a round, recorded in seconds and in tenths of a second, with parts of a second counting as the next whole second (e.g. 60.2 seconds is recorded as 61 seconds), is the time taken by a competitor to complete the round, plus the time correction if any.
- It starts at the precise moment when the mounted competitor passes the starting line in the correct direction providing the starting signal has been given, or at the moment 45 second countdown expires. It extends to the moment when the mounted competitor crosses the finishing line in the correct direction, after having jumped the last obstacle.
- Supported by one manual timer, electronic timing is strongly recommended.
- If electronic timers are not used, two manual timers, one of which is to be in line with both the start and finish lines, and has direct contact with the Jury, regardless if electronic timers are used or not, are required for all divisions.

##### B. Time Limit

The time limit is equal to twice the time allowed for all competitions in which a time allowed has been laid down.

##### C. Time Allowed

The time allowed for a round in each competition is determined in relation to the length of the course and the speeds laid down.

##### D. Time Adjustment

The time allowed may be adjusted at the sole discretion of the judge(s), if they feel that a gross error in the measurement of the course has been made. This change may occur only after consultation with the course designer and TD. Adjustment of the time allowed may never occur later than after the completion of a third round without disobedience. The time allowed may never be lowered resulting in the awarding of time faults to any competitors having ridden prior to the change without disobedience.

##### E. Reference Times

The time allowed should be announced prior to the start of the class. After the first three competitors to complete the class without disobedience have completed their rounds, the time allowed and their times should be announced jointly. In cases where there is no electronic read-out board, or it is not visible to riders in the in-gate area, the reference times for all the competitors in the class should be announced, along with their score.

##### F. Interrupted Time

- While the clock is stopped, the competitor remains free to move around until the ringing of the bell gives them permission to start again. The clock is restarted when the competitor reaches the place where the clock was stopped. Exception, in the case of a disobedience with a knock-down Article 52.I applies.
- The responsibility for starting and stopping the clock rests solely with the judge in charge of the bell. The timekeeper may not be made responsible for this function.

##### G. Disobediences During Interrupted Time

- The time of a round is interrupted only under the provisions of Article 52.I. The clock is not stopped in the event of a deviation from the course, a runout or a refusal.
- Disobediences are not penalized during interrupted time, except for the 2nd refusal following a refusal with a knockdown.
- The provisions concerning elimination remain in force during interrupted time.

##### H. Time Corrections

If, as the result of a disobedience, a competitor displaces or knocks down any obstacle, the bell is rung and the clock is stopped until the obstacle has been rebuilt. When the obstacle has been rebuilt the bell is rung to indicate that the course is ready and that the competitor can continue the round. The competitor is penalized for a refusal and a time correction of 6 seconds is added to the time taken by the competitor to complete their round. The clock is restarted at the moment when the mount leaves the ground at the obstacle where the refusal occurred. If a disobedience with the knock-down occurs at the second or subsequent part of a combination the clock is restarted when the mount leaves the ground at the first element of the combination.

##### I. Stopping During the Round

- In the event of a competitor not being able to continue their round for any reason or unforeseen circumstance, the bell should be rung to stop the competitor. As soon as it is evident that the competitor is stopping, the clock will be stopped. As soon as the

# SECTION III: Competition

---

course is ready again, the bell will be rung, and the clock will be restarted when the competitor reaches the precise place where the clock was stopped.

- If the competitor does not stop when the bell is rung, they continue at their own risk, and the clock should not be stopped. The discipline ground jury must decide whether the competitor is to be eliminated for ignoring the order to stop, or whether, under the circumstances, they should be allowed to continue. If the competitor is not eliminated, and is allowed to continue their round, the scores obtained at the obstacles preceding and following the order to stop will count whether they are good or bad.
- If the competitor stops voluntarily to signal to the discipline ground jury that the obstacle to be jumped is wrongly built or if due to unforeseen circumstances beyond the control of the competitor, they are prevented from continuing their round under normal circumstances, the clock must be stopped immediately.
  - If the dimensions are correct and the obstacle in question has been properly built or if the so-called unforeseen circumstances are not accepted as such by the discipline ground jury, the competitor will be penalized as for stopping during the round and the time of their round will be increased by 6 seconds;
  - If the obstacle or part of the obstacle needs to be rebuilt or if the unforeseen circumstances are accepted as such by the discipline ground jury, the competitor is not penalized. The time of the interruption must be deducted and the clock stopped until the moment when the competitor takes up their track at the point where they stopped. Any delay incurred by the competitor must be taken into consideration and an appropriate number of seconds deducted from their recorded time.

### 3. The Bell (Signal)

- A. The bell (or other sound) is used to communicate with the competitors. One of the members of the discipline ground jury or the additional judge is in charge of the bell and responsible for its use. The bell is used:
  - To give permission to the competitors to enter the arena when the course is ready for their inspection and to signal that the inspection time is over
  - To give the signal to start and to activate a 45-second countdown. The 45-second countdown sets the time that the competitor can spare before commencing their round. The discipline ground jury has the right to interrupt the 45-second countdown if unforeseen circumstances occur. Disobediences, falls, etc., occurring between the signal to start and the moment the competitor crosses the starting line in the correct direction, are not penalized. After the bell has rung, crossing the starting line in the correct direction for a second time before jumping the first obstacle is counted as disobedience.
  - To stop a competitor for any reason or following an unforeseen incident and to signal to them to continue

their round after an interruption

- To indicate to them that an obstacle knocked down, following a disobedience, has been replaced
- To indicate by prolonged and repeated ringing that the competitor has been eliminated
- B. If the competitor does not obey the signal to stop, they may be eliminated at the discretion of the discipline ground jury except where specifically provided for.
- C. If, after an interruption, the competitor restarts and jumps or attempts to jump without waiting for the bell to ring, they will be eliminated.
- D. Unauthorized Assistance Specific to Jumping Test
  - Any intervention by a third party between the crossing of the starting line in the correct direction and the crossing of the finishing line after jumping the last obstacle, whether solicited or not, with the object of helping the competitor or their mount is considered to be unauthorized assistance.
  - Any form of unauthorized assistance received by a mounted competitor between the starting line and the finishing line will be penalized by elimination at the discretion of the discipline ground jury.
    - In certain exceptional cases, the discipline ground jury may authorize the competitor to enter the arena on foot or with the help of a groom without this being considered as unauthorized assistance.
    - Any help given to a mounted competitor to adjust their saddlery or bridle or to hand them a whip while mounted during the round will incur elimination. To hand a mounted competitor their headgear and/or spectacles during their round is not considered to be unauthorized assistance.
    - Following a fall or when they have voluntarily dismounted, all assistance given to a competitor, for example bringing back their mount, helping them readjust saddlery, handing them their whip while dismounted or helping them get back in the saddle, is not considered as unauthorized assistance.
    - The act of officials or other persons of warning a competitor of a deviation from the course constitutes unauthorized assistance. In this event the competitor may be eliminated at the discretion of the discipline ground jury and the official or other persons may be subject to a penalty at the discretion of the discipline ground jury.

### Article 53—Arena and Course

The arena must be enclosed. While a mount is in the arena during a competition, all entrances and exits must be physically closed. Where the arena size is less than 5000 square meters (approximately 90m x 55m [300 ft x 180 ft]) the maximum speed to be used for any division shall be 350 meters/minute. In arenas of less than 2300 square meters (approximately 75m x 30m [250

# SECTION III: Competition

---

ft x 100 ft) the maximum speed to be used shall be 325 meters/minute.

## 1. Marking the Course:

A. Completely red flags and completely white flags must be used to mark the following details of the course:

- The starting line.
- The limits of the obstacles; the flags may be attached to any part of the wings of the obstacles. They may also stand independently. One red flag and one white flag must be placed at vertical obstacles and at least two red and two white flags to define the limits of spread obstacles. They must also be used to mark the limits of the obstacles provided in the schooling (warm-up) areas.

- The finishing line

## 2. Courses And Measuring:

A. Within the limits shown in Appendix VIII, the course designer is free to plan a track suitable to the level of the competition. It is permissible, with the approval of the TD and discipline ground jury, to add up to 10% of the maximum permitted distance.

B. The TD and/or the discipline ground jury must walk the course to inspect the obstacles before the start of the competition. The course is the track, which the mounted competitor must follow when competing from passing the start in the correct direction up to the finish. The length must be measured accurately to the nearest meter taking into account, particularly on the turns, the normal line to be followed by the mount. This normal line must pass through the middle of the obstacle.

## 3. Start and Finish:

The starting and finishing lines may not be more than 15m nor less than 6m from the first and last obstacle. These two lines must each be marked with an entirely red flag on the right and an entirely white flag on the left

## 4. Course Plan:

A. A plan showing accurately all the details of the course must be posted as close as possible to the entrance of the arena, at least half an hour before the beginning of each competition. An identical copy must be given to the discipline ground jury.

B. The obstacles are numbered consecutively in the order in which they must be jumped.

C. Combination obstacles carry only a single number. This number may be repeated at each element for the benefit of the discipline ground jury and competitors. In this case, distinguishing letters will be added (for example: 8A, 8B, 8C etc).

D. The plan must indicate the following:

- The position of the starting and finishing lines.

- The relative position, type (spread or vertical obstacle, triple bar) numbering and lettering of obstacles.
- The track to be followed by competitors marked by a series of arrows showing the direction in which each obstacle must be jumped.
- The time allowed and time limit.
- All decisions and/or modifications made by the discipline ground jury in regard to the course.

## Article 54—Jumping Test Obstacles

1. At the obstacles, the starting and finishing lines, the competitor must pass between the flags (red on the right and white on the left).

2. Knocking down a flag anywhere in the arena does not incur a penalty. If a flag marking the limits of an obstacle or the finishing line has been knocked down following a disobedience/resistance, (without passing these lines) or as a result of unforeseen circumstances, the flag will not be replaced immediately; the competitor must continue their round and the obstacle will be judged as if the flag was in its original place. The flag must be replaced before the next competitor will be given the signal to start.

3. The obstacles must be inviting in their overall shape and appearance, varied and match their surroundings. Both the obstacles themselves and their constituent parts must be such that they can be knocked down, while not being so light that they fall at the slightest touch or so heavy that they may cause mounts to fall or be injured.

4. The obstacles must not be unsporting and they must not cause an unpleasant surprise.

5. The obstacles should have a balance of vertical and spread obstacles. Closed combinations are not permitted. A water jump is not permitted, but a liverpool no wider than 1.8m (6ft.) with rails over the water is allowed.

6. Poles and other parts of the obstacles are held up by supports (cups). The pole must be able to roll on its support; in this case the support for the top poles should have an ideal depth of 25 mm (1"), in any case the minimum depth is to be 20 mm (¾") or a maximum depth of 30mm (1 ¼"). For planks, balustrades, barriers, gates, etc. the supports must be more open or even flat, with a maximum depth of 13 mm (½").

7. The minimum length of the jumping element of an obstacle is 1.8 m (6ft).

8. Within the limits shown in Appendix VIII, at least one third of the obstacles shall be of maximum height, except for Beginner Novice and Novice Levels where there is no minimum requirements. The top spread of an oxer may be no more than 25cm (10") wider than the height of the obstacle. The base width of an oxer, or triple bar, may be no more than 50cm (20") wider than the height of the obstacle.

# SECTION III: Competition

---

9. However, if it should happen that a maximum dimension has been marginally exceeded as a result of the material used for construction and/or by the position of the obstacle on the ground, the maximum dimensions laid down will not be considered as having been exceeded, but the permitted tolerance is 50 mm (2") maximum in height and 100 mm (4") in width.

## 10. Vertical Obstacle

An obstacle whatever its construction can only be called vertical when all the parts of which it is composed are positioned in the same vertical plane on the take-off side. If a wall projects forward of this vertical plane, the jury has to decide before the start of the competition if this is faultable. A take off box may be deemed by the jury as decoration and not faultable. The same applies to the front element of a spread obstacle.

## 11. Spread Obstacle

A spread obstacle (oxer or triple bar) is an obstacle, which is built in such a manner that it requires an effort both in spread and in height. Only one pole may be used on the back of any spread obstacle. Approved safety cups must be used as support for the back pole of all spread obstacles and in case of a triple-bar to support all center and back poles of the obstacle.

## 12. Combinations

- A. Double or triple combinations mean a group of two or more obstacles, with distances between the elements of 7m (23ft) minimum and 12 m (39ft 5in) maximum which require two or more successive efforts. The distance is measured from the base of the obstacle on the landing side to the base of the next obstacle on the take-off side.
- B. In combinations, each element of the group must be jumped separately and consecutively, without circling around any element. Faults committed at any element of a combination are penalized separately.
- C. When there is a refusal or run-out, the competitor must retake all the elements.
- D. Penalties for faults made at each element and during different attempts, are counted separately and added together.
- E. In a combination obstacle a triple bar may only be used as the first element.

## 13. Alternative Obstacles

- A. Alternative obstacles are permitted. These jumps are to be marked on the course plan with the same number and the word 'Alternative'. The competitor has the choice of jumping either one of the obstacles.
- B. If there is a refusal or run-out without a knock-down or displacing of the obstacle, at the next attempt the

competitor is not obliged to jump the obstacle at which the refusal or run-out occurred. He may jump the obstacle of their choice.

- C. If there is a refusal or run-out with a knock-down or displacing of the obstacle, he may only restart their round when the obstacle knocked down or displaced has been replaced and when the discipline ground jury gives them the signal to start. He may then jump the obstacle of their choice.
- D. Red and white flags must be placed at each of the elements of these alternative obstacles.

## Article 55—Jumping Test Definitions of Faults

### 1. Disobediences

- A. The following are considered as disobediences and are penalized as such:
  - A refusal
  - A run-out
  - A resistance
  - A more or less regular circle or group of circles no matter where they occur on the course or for whatever reason. It is also a disobedience to circle around the last obstacle jumped unless the track of the course so requires.
- B. Notwithstanding the above, it is not considered to be a disobedience to circle for up to 45 seconds after a run-out or a refusal (no matter if the obstacle has to be rebuilt or not) to get into position to jump an obstacle

### 2. Deviation from the Course.

- A. It is a deviation from the course when the competitor:
  - Does not follow the course as set out on the published plan
  - Does not cross the starting line or the finishing line between the flags in the correct direction
  - Does not jump the obstacles in the order or in the direction indicated
  - Jumps or attempts to jump an obstacle which does not form part of the course or omits an obstacle. Obstacles not included in the course should be crossed but failure to do so by the arena party will not preclude the elimination of a competitor for jumping an obstacle not forming part of the course.
- B. An uncorrected deviation from the course incurs elimination

### 3. Refusal

- A. It is a refusal when a mount halts in front of an obstacle, which it must jump whether or not the mount knocks it down or displaces it.
- B. Stopping in front of an obstacle without moving backwards and without knocking it down followed immediately by a standing jump is not penalized.

# SECTION III: Competition

---

- C. If the halt is prolonged, if the mount steps back, either voluntarily or not, even a single pace, it counts as a refusal.
  - D. If a mount slides through an obstacle, the judge in charge of the bell must decide immediately if it is to count as a refusal or as an obstacle knocked down. If they decide that it is a refusal, the bell is rung at once and the competitor must be ready to attempt the obstacle again as soon as it has been rebuilt
    - If the judge decides that it is not a refusal, the bell is not rung and the competitor must continue their round. They are then penalized as for an obstacle knocked down.
    - If the bell has been rung and the competitor jumps other elements of the combination in their stride, it does not entail elimination or any further penalty should they knock down this element of the combination.
4. Run-Out
- A. It is a run-out when the mount escapes the control of its competitor and avoids an obstacle, which it has to jump.
  - B. When a mount jumps an obstacle between two red flags or between two white flags the obstacle has not been jumped correctly, the competitor is penalized as for a run-out and they must jump the obstacle again correctly.
  - C. It is considered to be a run out and is penalized as such for a mount or any part of a mount to go past the extended line of an obstacle to be jumped, or of an element of a combination, or of the finishing line
5. Resistance
- A. It is a resistance when the mount refuses to go forward, makes a halt for any reason, makes one or several more or less regular or complete half turns, rears or steps back for whatever reason.
  - B. It is equally a resistance when the competitor stops their mount at any moment and for any reason, except in the event of an incorrectly rebuilt obstacle or to indicate unforeseen circumstances to the discipline ground jury. A resistance is penalized as for a refusal except in the circumstances set out in rule Article 60.C.
6. Falls
- A. A competitor is considered to have fallen when, either voluntarily or involuntarily, the competitor is separated from their mount, which has not fallen, in such a way that the competitor touches the ground or finds it necessary, in order to get back into the saddle, to use some form of support or outside assistance. If it is not clear that the competitor has used some form of support or outside assistance to prevent their fall, the benefit of doubt must be given to the competitor.

- B. A mount is considered to have fallen when at the same time both its shoulder and quarters have touched either the ground or the obstacle and the ground.

## Article 56—Scoring of Jumping Test

1. During a round, penalties are incurred for:
  - A. Knocking down an obstacle
  - B. A disobedience
  - C. A deviation from the course
  - D. A fall of a mount and/or competitor
  - E. Unauthorized assistance
  - F. Exceeding the time allowed or the time limit

### 2. Knock Down

An obstacle is considered to have been knocked down when, through a mistake of the mount or competitor:

- A. The whole or any upper part of the same vertical plane of it falls, even if the part which falls is arrested in its fall by any other part of the obstacle.
- B. At least one of its ends no longer rests on any part of its support.
- C. Touches and displacements of any part of an obstacle or its flags, in whatever direction, while in the act of jumping, do not count as a knock down. If in doubt the discipline ground jury should decide in favor of the competitor. The knock down or displacement of an obstacle as a result of a disobedience is penalized as a refusal only. In the event of the displacement of any part of an obstacle, (except the flags), as a result of a disobedience, the bell will be rung and the clock stopped while the displacement is re-adjusted. This does not count as a knock down and is only penalized as a disobedience and corrected by time in accordance with Article 52.H.
- D. If any part of an obstacle, which has been knocked down is likely to impede a competitor in jumping another obstacle, the bell must be rung and the clock stopped while this part is picked up and the way is cleared.
- E. If a competitor jumps an obstacle correctly which has been improperly rebuilt, there incurs no penalty; but if they knock down the obstacle they will be penalized.

### 3. Vertical and Spread Obstacles

- A. When a vertical obstacle or part of an obstacle comprises two or several parts placed one above the other and positioned in the same vertical plane, only the fall of the top part is penalized.
- B. When a spread obstacle which requires only one effort comprises parts which are not positioned in the same vertical plane, the fall of one or several top parts only counts as one fault whatever the number and position of the parts which have fallen. Trees, hedges etc. used as falling are not liable for penalties.

# SECTION III: Competition

---

4. Faults made between the starting line and the finishing line must be taken into consideration.
5. Disobediences committed during the time when the round is interrupted are not penalized.
6. Disobediences, falls etc., occurring between the signal to start and the moment the competitor crosses the starting line in the correct direction, are not penalized.
7. Penalties for the disobediences accumulate, not just at the same obstacle, but throughout the entire round
8. Calculating the Jumping Test Penalties
  - A. Total any jumping penalties, and time penalties competitors jumping test and add to the existing penalty score.  
Faults are penalized in penalty points or by elimination as set out in this section

- Obstacle knocked down while jumping 4 penalties
- First disobedience ..... 4 penalties
- Second disobedience at Beginner Novice, Novice, Training, and Modified..... 8 penalties
- Third disobedience at Beginner Novice, Novice, Training, and Modified..... Elimination
- Fall of mount or competitor or both..... Elimination
- Exceeding the time limit..... Elimination
- Exceeding the time allowed..... 0.4 penalty for each second or commenced fraction of a second

Penalties for the disobediences accumulate, not just at the same obstacle, but throughout the entire round.



# SECTION IV: Scoring

---

## Article 57—Points and Penalties

Points and penalties in Eventing vary based on the phase. Please see the appropriate scoring section within each phase.

## Article 58—Inquiries, Protests, and Appeals

- Only competitors have the right to dispute scores and only competitors can participate in the process. Any non-competitor involvement in the process is considered unauthorized assistance.
- Competitors may only inquire about their team/individual scores.
- Inquiries are encouraged if there are any scores with which the team does not agree or understand, or if they feel a mistake has occurred. Any disputes regarding scores are to be made following the procedures as stated in the governing documents.
- All inquiries, protests and appeals must be made in a polite and courteous manner. Abuse of these procedures or rude behavior may be penalized up to and including elimination and/or disqualification.
- The process will include verbal inquiry, written inquiry, written protest and written appeal, and use Appendix I.

## Horse Management

### Horse Management Verbal Inquiry

Verbal inquiries may be initiated if the team captain/individual competitor does not agree or understand or if they feel a mistake has been made. Horse Management verbal inquiries are made to the CHMJ following the posting of scores.

*Inquiries must be:*

Initiated within 30 minutes from the time the score sheet(s) are posted by the CHMJ, and made in person by:

- The team captain, if competitor is on a team. The competitor involved may go with the team captain.
- The competitor involved (if competing as an individual).

If the team captain is riding when scores are posted and will not be available within the allowed thirty-minute period, another team member may notify the CHMJ that an inquiry is likely.

At the end of the required 30 minute inquiry period, the CHMJ must:

- Make any necessary adjustments/changes to scores based on the outcome of any inquiries that may have been made and are settled. (Only the CHMJ may adjust points as a result of inquiries).
- Transcribe any changes in scores to the HM master score sheet and turn in master score sheet to the rally scorer.
- No further inquiries will be permitted, except for transcription errors. Transcription errors are a discrepancy between actual scores shown on Horse Management sheets and scores posted by the scorer.

### Horse Management Written Inquiry

Written inquiries may be initiated if the team captain/individual competitor disagrees with the CHMJ's decision on a verbal inquiry. Written Inquiries are made to the TD/steward via the rally office.

*Written inquiries must be:*

Made in writing, using the official Horse Management Written Inquiry Form (signed by the team captain/individual competitor), containing the references to the rules covering the reason for the inquiry.

Delivered within 30 minutes of the CHMJ decision on the verbal inquiry to the rally office.

## Mounted Competition

### Mounted Competition Scoring Written Inquiry

Written inquiries may be initiated if the team captain/individual competitor does not understand or if they feel a mistake has been made. Mounted competition written inquiries are made to the TD/steward following the posting of scores.

*Inquiries must be:*

Initiated within 30 minutes from the time the score sheet(s) are posted and made in person by:

- The team captain, if competitor is on a team. The competitor involved may go with the team captain.
- The competitor involved (if competing as an individual).

If the team captain is riding when scores are posted and will not be available within the allowed thirty-minute period, another team member may notify the rally office that an inquiry is likely.

## Written Protest to the Discipline Ground Jury

If a team does not agree with the TD/steward's decision on a written inquiry, they may advance a written protest (utilizing the existing written inquiry form) to the discipline ground jury.

The decision must be made while the team is sequestered and within 10 minutes after the TD/steward's announcement of the decision to the team.

*Written protests must be:*

Initiated by:

- The team captain, if competitor is on a team. The competitor involved may go with the team captain.
- The competitor involved (if competing as an individual).
- Made within 10 minutes of the TD/steward's announcement of the decision to the team.

# SECTION IV: Scoring

## Frivolous Protest

- During a rally, each team is allowed one “free” protest to the TD/steward. After the first, the TD/steward may present to the ground jury any protest presented in which the decision of the judge was upheld and which the TD/steward deems frivolous and not in the spirit of good sportsmanship. Any protest deemed frivolous, may be assessed 5 points by the discipline ground jury.
- If any score change results, the chief scorekeeper must be notified by the official making the decision and changes recorded scores.

The discipline ground jury will meet, review the written inquiry/protest form, make a decision, document the decision on the original written inquiry/protest form, and report its decision.

THE DECISION OF THE DISCIPLINE GROUND JURY IS FINAL AT REGIONAL RALLIES.

## Written Appeal to the Championships Overall Ground Jury

If a team does not agree with the discipline ground jury’s decision on a written protest, they may advance an appeal (utilizing the existing written inquiry form) to the championships overall ground jury/appeal committee.

The team’s decision to appeal must be made while the team is sequestered and within 10 minutes after the announcement of the discipline ground jury’s decision to the team.

Appeals must be initiated by:

- The team captain, if competitor is on a team. The competitor involved may go with the team captain.
- The competitor involved (if competing as an individual).

THE DECISION OF THE CHAMPIONSHIPS OVERALL GROUND JURY IS FINAL.

## Article 59—Scoring of Excused

Excused competitors/mounts will receive same score as an elimination score for any phase from which they are excused. Competitors/mounts may rejoin the competition at the discretion of the discipline ground jury.

## Article 60—Scoring of Elimination

1. Competitors eliminated or retired during any phase of the rally will receive penalties as if eliminated for that phase in accordance with the table below. Scores for prior phases will stand.
  - A. If allowed to continue, subsequent scores will count.
  - B. If not allowed to continue in subsequent riding phases, riders will be scored as if eliminated in each of those phases.
  - C. For the phase in which the rider was eliminated or is scored as if eliminated, penalty points will be added to

the worst score of a competitor in the same division in that phases follows:

Dressage.....	20 penalty points
Cross-Country .....	50 penalty points
Jumping .....	15 penalty points

2. Withdrawn competitors’ scores for phases prior to their withdrawal stand. They will be scored as if eliminated in all subsequent phases.
3. See appropriate chapters in Section III for possible reasons for elimination. Elimination is left to the discretion of the discipline ground jury in the following cases:
  - A. Not entering the arena when the competitor’s name and/or number is called.
  - B. Not entering the arena mounted or not leaving the arena mounted.
  - C. All unauthorized assistance, except for paragraph above.
  - D. Not stopping when the bell is rung during the round.

## Article 61—Scoring of Disqualification

The discipline ground jury may disqualify a competitor and/or a team from competition, for the reasons stated in Article 21. Or the discipline ground jury may decide to issue a Yellow (Warning) Card in lieu of disqualifying a competitor. Decisions of the discipline ground jury are not appealable except at Championships.

1. If a Yellow Card is accessed to a competitor, it may or may not include penalty points. The discipline ground jury can access penalties ranging from 0 up to the maximum penalties as defined below. Any accessed penalties should be included in the “Other” column on the scoresheet and are added to the penalty score prior to combining them with the Horse Management Score.

Dressage—The maximum number of penalties accessible for infractions related to the Dressage phase is 50 penalties added to the final penalty score.

Cross-Country—The maximum number of penalties accessible for infractions related to the Cross-Country phase is 148 penalties added to the final penalty score.

Jumping—The maximum number of penalties accessible for infractions related to the Jumping phase is 51 penalties added to the final penalty score.

Full Competition—For infractions related to the entire competition, the maximum number of penalties is 249 penalties added to the final rider penalty score.

## SECTION IV: Scoring

---

2. Competitors (or teams) who are disqualified from competition shall have all their scores from the competition stricken. If the disqualification of a competitor causes an already short team, to become a shortened team, then shortened team ghost scoring will apply. If a stable manager is disqualified, all the team's accumulated Horse Management points will be split evenly among the remaining team members.

Disqualified competitors and their mounts may not take further part in the rally and may be asked to leave the grounds. A disqualified competitor/team may not receive an award.

### Article 62—Team Scoring

1. Based on the number of mounted competitors, teams may or may not have a drop score. Four rider teams will drop the worst (highest) penalty score for each phase of the mounted competition. Three rider teams will keep all three scores from each phase. If Horse Management ghost scores are needed, those will be calculated per the current Horse Management Handbook.

The final score is calculated using the below formula.

Horse Management Score = # HM penalties x 4

Final Score = Dressage penalties + Cross-Country penalties + Jumping penalties + HM Final Score

2. In extraordinary circumstances when a short team (three rider team) becomes a shortened team (two rider and one stable manager), prior to the start of competition, the following team scoring will take effect.
  - A. In the event of the competitor being removed completely from the team. Ghost Horse Management scores will be determined per the Horse Management Handbook. Ghost riding scores will be determined by averaging the riding scores of the two remaining competitors.
  - B. In the event of the competitor no longer being able to participate in the riding portion of the competition. They shall continue to earn Horse Management scores, and ghost riding scores will be determined by averaging the riding scores of the two remaining competitors.

Please note: The above scoring is not to be used in a 4 man team's loss of a rider or mount. Only to be used with a 3 man team rather than losing a team completely from the rally.

### Article 63—Individual Scoring

While rallies are normally scored only as teams, there are some instances when the tabulation of individual scores is necessary. To determine an individual's score:

1. The penalties accumulated in each of the three phases will be added together.
2. The total penalty score, plus all Horse Management penalties (after factoring), will be added.

3. The winning individual is that individual who has the lowest total score after all scores have been added. In the event of a tie, the tie will be broken by:

- A. The best cross-country score including penalties for faults at obstacles, time penalties and any other penalty that they may have incurred on the cross-country test.
- B. Closest to the optimum time on cross-country.
- C. Best jumping score including penalties at obstacles and time penalties.
- D. Best collective marks in the Dressage test.

### Article 64—Posting of Scores

Depending on the length of the rally, scores may be posted multiple times during the rally or just once. Any time scores are posted there is a 30-minute inquiry period where competitors can inquire regarding the scores (Article 58). After the final inquiry period, the only changes that can occur are if a transcription error has occurred. Following the final inquiry period, final scores for all competitors must be posted for review by competitors, parents, coaches, etc.

Anytime scores are posted during the competition, there will be an announcement of official score posting and time.

ELIMINATION/RETIREMENT/WITHDRAWAL/DISQUALIFICATION ON THE SCOREBOARD:

- Eliminated mount/riders are indicated by (E) on the scoreboard.
- Technical Elimination mount/riders are indicated by (TE) on the scoreboard.
- Retired mount/riders are indicated by (R)
- Mandatory Retirement by (MR).
- Withdrawn mount/riders are indicated by (W).
- Disqualified mount/riders are indicated by (D).
- Mounts excluded from competition at the Jog-Out or Vet Check are indicated by (X).

### Article 65—Placing of Teams

The winning team is that with the best (lowest) final score after all three riding scores and the Horse Management score are added together.

#### Ties:

Will be broken by the following order. The winning team will be that team whose third-placed competitor has:

1. The lowest number of final penalty points
2. The closest to optimum time on XC
3. The lowest Dressage score

#### Awards:

Overall team and Horse Management awards are usually presented at mounted rallies. Other awards may be also be given and all awards must be published in the prize list.

# SECTION IV: Scoring

---

**Please Note:**

1. A disqualified mount/rider combination may not be placed or receive an award.

2. Combined Test Rallies:

- A. Teams at all levels and individuals at combined test rallies are classified as they are at Eventing rallies
- B. There is no combined test Championship.
- C. Ties: Ties are broken as they are at Eventing rallies.

# SECTION V: Officiation

---

## Overview

The use of appropriately licensed (US Equestrian, etc.) officials is always preferable. Regarding standard rallies, appropriately licensed officials may be required. However, realizing that not every area has Pony Club-oriented licensed officials easily available, rally organizers are asked to utilize suitably experienced personnel to fill official positions. Organizers needing help are encouraged to reach out to the Competitions committee (refer to [www.ponyclub.org/About/Contact Us/ActivitiesCommittees](http://www.ponyclub.org/About/Contact%20Us/ActivitiesCommittees) to find contact information). These resource people, available by e-mail, or phone, can help with courses, officials, or other questions.

## Article 66—Rally Organizer

The rally organizer serves as the manager of the competition. They must be on the grounds during competition and available to rally officials in the event a problem arises concerning the facility or equipment. Rally organizers do not participate in the officiation, unless required due to extenuating circumstances. They must engage individuals necessary to fill all official capacities at the competition. Full details and job descriptions for rally organizers are available in the Rally Organizer's Guide.

## Article 67—Technical Delegate (TD)

The TD oversees the technical and administrative arrangements for a competition. They are responsible for knowing and enforcing the rules of the competition. The TD is the person to whom an inquiry is presented by the team captain in the event of a question regarding mathematical errors or scoring irregularities. If the initial inquiry to the TD fails to resolve the question at hand, the discipline ground jury then makes a final decision. The TD may not be a member of the discipline ground jury.

For standard rallies, USPC highly recommends the TD be chosen from the current USEF TD list.

1. The organizer shall appoint a knowledgeable person to serve as TD.
  - A. The TD shall act with complete impartiality and report to the organizer and eventing committee, protecting the interests of competitors, judges, officials and the competition organizers. The TD shall have no connection with the management or judging of a competition.
  - B. No TD may officiate at any competition in which a member of their family, any owned mounts or any of their students are competing.
  - C. No competition shall be organized and held without the presence of a TD.
2. The duties, powers, and responsibilities of the TD are defined as follows:
  - A. To protect the interests of competitors, judges, and rally organizers
  - B. Ensuring the Eventing rally is organized and managed

in strict compliance with the USPC Eventing Rules

- C. To inspect and approve: arenas and courses; to include, but not limited to, the dimensions of the obstacles and length of the courses; inspection of warm up areas; accommodations for mounts, where appropriate; vehicle parking arrangements and all other physical aspects of the rally
  - D. To ensure that the courses are at the standard of the level offered, and that prior knowledge of local conditions does not play any part, and if a qualifying rally, the courses are of sufficient difficulty to prepare the riders for Championship competition
  - E. To instruct the organizer to make any alterations to the course or arenas, or to any technical detail associated with the conduct of the competition which they consider necessary. The course must be inspected early enough to allow for modifications to be made
  - F. Supervising the horse inspections
  - G. Once the competition begins, the TD is responsible for accounting for the presence of all competitors and mounts on rally grounds. Any withdrawals of mounts or riders must be reported to the TD as soon as possible
  - H. Supervising the technical conduct of the competition
  - I. Reporting any infraction or violation of the competition rules and regulations to the organizer by any competitor, coach, manager, competition official, staff member or any other person present on the competition grounds, and seeing that immediate action is taken
  - J. Furnishing USPC with a complete written report on the competition, including any infractions or violations of the rules, within three days following completion of the competition. (See Appendix V.)
3. Thereafter, the responsibility for the rally rests on the discipline ground jury. The TD will continue to supervise the technical and administrative conduct of the rally, and will advise and assist the discipline ground jury and the organizing committee. Specific areas will include the following:
- A. Supervising the briefing and conduct of all technical personnel.
  - B. Investigating all inquiries regarding scoring, including penalties awarded, report to and advise the discipline ground jury on any decisions they are required to make.
  - C. The TD for all rallies needs to submit a USPC TD form promptly to the USPC National Office. The completed TD report serves as documentation that a rally met the USPC requirements for a standard Eventing rally. The TD Report is available in this rulebook and online.
  - D. At rallies where the ground jury is occupied by judging the Dressage and/or jumping test, the TD may need to supervise for the ground jury during Cross-Country.

# SECTION V: Officiation

---

- E. The following may not serve as the TD at a rally: a member of the discipline ground jury or appeal committee, the course designer, or an officiating dressage or jumping judge.

## Article 68—Discipline Ground Jury

The discipline ground jury is the group that adjudicates and administers the rally. The discipline ground jury makes proper inquiries into both sides of cases in all protests concerning decisions made by the TD and other officials during a rally.

The discipline ground jury shall be composed of the chief judge, the CHMJ, and one other Pony Club knowledgeable person as appointed by the rally organizer.

The following persons are ineligible to serve on the discipline ground jury:

1. Any competitor, manager, chaperone, coach, or owner of a mount entered in the competition
2. Any close relative of a person named in item 1 above
3. Any instructor or trainer of any competitor or mount entered in the competition
4. The organizer or any member of the organizing committee
5. Any other horse management judge from that competition
6. The TD

### Duties of the Discipline Ground Jury:

1. The discipline ground jury is ultimately responsible for the judging of the rally and for settling all problems that may arise during its jurisdiction. Together with the TD and organizing committee shall ensure that all arrangements for the rally, including that all competition areas are appropriate. If, after consultation with the TD, the discipline ground jury is not satisfied with the arrangements or areas, it has the authority to modify them.
2. The discipline ground jury will be responsible for determining objections against decisions by technical personnel, including judges and time-keepers, and may substitute their judgement for that of any judge or official, whether or not in favor of the competitor.
3. The discipline ground jury oversees all phases of a rally and determines whether competitors may continue in the next phase, after elimination or excused.
4. The members of the discipline ground jury are obliged to be on the grounds from the official rally opening until awards have been made.
5. Any member of the discipline ground jury has the duty and authority at any time during the rally to disqualify any competitor who is unfit to continue because of physical exhaustion or impairment, abusive or dangerous behavior. There is no appeal against such a decision.

## Article 69—President of the Discipline Ground Jury

For standard rallies, the president of the ground jury must be selected from the current USEF list of approved event judges. For modified rallies, a USEF approved event judge is highly recommended.

## Article 70—Championships Overall Ground Jury

At Championships (when multiple disciplines are competing at the same time and on the same facility), there will be an overall ground jury composed of three to five persons to include: the VPA, the championships horse management organizer, and one or more knowledgeable horse persons designated by the organizer, one of whom will be designated president.

The purpose and duties of the championships overall ground jury include:

- Determine dress requirements for turnout inspections and competition; and responsibility for waiving of dress requirements when the heat/humidity index so indicates
- Decide issues that affect all disciplines at the Championships, so as to promote uniformity among the competitions
- Handle instances regarding the uniform application of disciplinary action for poor sportsmanship, cruelty or misbehavior by a competitor
- Make a proper inquiry into both sides of the cases in all appeals concerning decisions made by the discipline ground jury, or referred to the championships overall ground jury by the discipline ground jury

The decision of the championship overall ground jury is final.

The following may not serve on the championships overall ground jury:

- Anyone serving as a TD
- Anyone serving on a discipline ground jury
- Anyone serving as a CHMJ for the competition
- Anyone serving as a judge for the competition

## Article 71—Horse Management Judges

- All competitions shall include judging of horse management. Horse Management shall be judged in accordance with current USPC Horse Management Handbook. At all events, horse management judges will judge safety standards throughout the day.
- The horse management judges shall be responsible for conducting stable, turnout and turnback inspections.
- Horse management judges shall be responsible for safety checks. The safety checks will be performed in assigned areas, as close to warm up and jumping areas as feasible.

# SECTION V: Officiation

---

## Article 72—Chief Horse Management Judge (CHMJ)

One member of the rally horse management staff will be designated as the CHMJ. If the rally is a standard rally for Championships, the CHMJ must be selected from the current CHMJ list on the USPC website.

## Article 73—Course Designer

1. The organizer shall appoint a qualified course designer for the Cross-Country and Show Jumping. The course designer should supervise the layout of the course from the plan provided.
2. The course designer is responsible for course layouts and measurements, which comply with the rules and regulations governing the courses, and obstacles.
3. The course designer may do an official course walk with all competitors.

## Article 74—Additional Judges

If needed, the organizer may appoint additional judges to judge the Dressage test or jumping test. These judges are subject to the same qualifications and restrictions as members of the discipline ground jury, but are free to leave the grounds 30 minutes after their scores have been posted, unless they are serving on the discipline ground jury.

## Article 75—Inspection Panel

An inspection panel made up of the president of the discipline ground jury, the CHMJ, and a veterinarian or other qualified mount person, will officiate over the horse inspections (jogging). The veterinarian's decision shall be final when a judge or the steward requests an inspection or examination as to the serviceable soundness of a mount. In the absence of a veterinarian, the judges or the steward shall have the right to excuse a mount from further participation on the grounds of unsoundness.

## Article 76—Veterinarians

- The veterinarian should be a part of the inspection panel for all horse inspections.
- Regional competitions should have a qualified veterinarian present during the jogs, cross-country and jumping phases of the competition.
- The veterinarian shall assist the organizer in all matters pertaining to the health and welfare of the mounts at the competition.
- The veterinarian, when required to be present at a competition, shall have the right to inspect and examine any mount at the competition. The judges or the steward may request an inspection or an examination of any mount.
- The veterinarian's decision shall be final when a judge or the steward request an inspection or examination as to the serviceable soundness of a mount. In the absence of

a veterinarian, the judges or the steward shall have the right to excuse a mount from further participation on the grounds of unsoundness.

## Article 77—Chief Scorekeeper

- The chief scorekeeper is responsible for prompt and accurate scorekeeping. The judges and timekeepers provide factual data for the chief scorer to use in the calculation of scores and place standings.
- Accurate, up-to-the-minute scorekeeping is very important to keep the competitors, officials and spectators informed. Therefore, the judges and the chief scorekeeper shall work in close cooperation with the announcer.
- The chief scorekeeper shall appoint such assistants as they may require for the work. All scoring shall be conducted with complete impartiality.

## Article 78—Required Medical Personnel

1. For mounted rallies—An EMT-Basic (paid or volunteer) is required onsite one hour prior to the first ride of the rally and stay until riding concludes for the day. The EMT or rally organizer must be aware of the closest ambulance and hospital locations.
  - A. The EMT must:
    - Have CPR certification and license to perform basic assessment and non-invasive treatment.
    - Not have any other duties at the mounted rally.
    - Have a reliable means of communicating with the local EMS service and knowledge of the nearest hospital.
    - Have direct communication with all riding areas, especially those out of view.
    - Coordinate with the rally organizer on how to handle injured parties.
2. Additional Information:
  - A. An EMT who is Intermediate or Paramedic level, both meets and exceeds the minimum requirement.
  - B. Facility requirements may exceed the minimum USPC EMT requirement.
  - C. Rallies run as recognized events may exceed the minimum USPC EMT requirement.
  - D. An on-site ambulance is highly recommended, but not required.

# SECTION V: Officiation

---

## **Article 79—Safety Coordinator**

A safety coordinator, who shall be responsible for the establishment and coordination of medical services is recommended for all eventing rallies. As this shall include the transportation of injured competitors, the safety coordinator should not have any other duties during any cross-country or jumping tests. The safety coordinator must have Accident Report Forms and should read the USEA Safety Manual. Eventing rallies run in conjunction with a USEF/USEA event, are REQUIRED to have a safety coordinator that meets USEF/USEA rulebook requirements.



# SECTION VI: Eventing Appendices

---

## Appendix I: Mounted Competition Scoring Inquiry/Protest/Appeal Form

*Remember*

- Only competitors have the right to dispute scores and can participate in the process
- Before this form can be used, a verbal inquiry must have been made to the CHMJ for Horse Management score questions
- After submission to the TD/steward, no additional information can be added by the team

Date: \_\_\_\_\_ Discipline: \_\_\_\_\_ Division: \_\_\_\_\_ Team #s: \_\_\_\_\_

Team Captain Name and Phone Number: \_\_\_\_\_

Team Member # for Protest: \_\_\_\_\_ Team Member Certification: \_\_\_\_\_

State infraction and provide points assessed:

Statement of Protest:

References (Name reference and page number):

Signature of Team Captain/Competitor: \_\_\_\_\_

# SECTION VI: Eventing Appendices

## Appendix I: Mounted Competitions Inquiry/Protest/Appeal Form

### Written Inquiry/Protest/Appeal Review

#### For Official Use Only

---

Written Inquiry Disposition: Date/time: \_\_\_\_\_

Approved: \_\_\_\_\_ Denied: \_\_\_\_\_ Points awarded if any: \_\_\_\_\_

TD: \_\_\_\_\_

CHMJ (if HM related) \_\_\_\_\_

Team Captain: \_\_\_\_\_

Requesting Advance to Protest Yes: \_\_\_\_\_ No: \_\_\_\_\_

---

Protest Disposition: Date/time: \_\_\_\_\_

Approved: \_\_\_\_\_ Denied: \_\_\_\_\_ Points awarded if any: \_\_\_\_\_ Penalty, if any: \_\_\_\_\_

Discipline Ground Jury: \_\_\_\_\_

Team Captain: \_\_\_\_\_

Requesting Advance to Appeal (Championships ONLY) Yes: \_\_\_\_\_ No: \_\_\_\_\_

---

Appeal Disposition: Date/time: \_\_\_\_\_

Approved: \_\_\_\_\_ Denied: \_\_\_\_\_ Points awarded if any: \_\_\_\_\_ Penalty, if any: \_\_\_\_\_

Discipline Ground Jury/Appeal Committee (Championships ONLY): \_\_\_\_\_

Team Captain: \_\_\_\_\_

---

Received by Scorer: (to indicate receipt and adjustment of a change)

\_\_\_\_\_

# SECTION VI: Eventing Appendices

## Appendix II: Heat Illness and Heat Index Chart

HEAT ILLNESS	Symptoms	What to do
Heat Stroke	<ul style="list-style-type: none"> <li>Confusion</li> <li>Fainting</li> <li>Seizures</li> <li>Excessive sweating or red, hot, dry skin</li> <li>Very high body temperature</li> </ul>	<ul style="list-style-type: none"> <li>Contact Medical Personnel, EMT, or Call 911</li> </ul> <p><i>While waiting for help:</i></p> <ul style="list-style-type: none"> <li>Place person in shady, cool area</li> <li>Loosen clothing, or remove outer clothing</li> <li>Fan air, place ice packs in armpits, apply cool compresses</li> <li>Provide fluids (water)</li> </ul>
Heat Exhaustion	<ul style="list-style-type: none"> <li>Cool, moist skin</li> <li>Heavy sweating</li> <li>Headache</li> <li>Nausea or vomiting</li> <li>Dizziness</li> <li>Light Headaches</li> <li>Weakness</li> <li>Thirst</li> <li>Irritability</li> <li>Fast Heart Beat</li> </ul>	<ul style="list-style-type: none"> <li>Place person in shady, cool area</li> <li>Provide fluids (water)</li> <li>Cool person with cold compresses, ice packs, fans</li> </ul>
Heat Cramps	<ul style="list-style-type: none"> <li>Muscle Spasms</li> </ul>	<ul style="list-style-type: none"> <li>Rest in cool, shaded area</li> <li>Drink water</li> <li>Wait a few hours before returning to play</li> </ul>

		Relative Humidity (%)																			
		5	10	15	20	25	30	35	40	45	50	55	60	65	70	75	80	85	90	95	100
Temperature (°F)	80	77	78	78	79	79	79	80	80	80	81	81	82	82	83	84	84	85	86	86	87
	81	78	79	79	79	80	80	81	81	82	83	84	84	85	86	86	87	88	89	90	91
	82	79	80	80	80	80	81	81	82	83	84	84	85	86	88	89	90	91	93	93	95
	83	79	80	80	81	81	81	82	82	83	84	85	86	87	88	90	91	93	95	97	99
	84	80	81	81	81	82	82	83	83	84	85	86	88	89	90	92	94	96	98	100	103
	85	81	81	82	82	82	83	84	84	85	86	88	89	91	93	95	97	99	102	104	107
	86	81	82	83	83	83	84	85	85	87	88	89	91	93	95	97	100	102	105	108	112
	87	82	83	83	84	84	85	86	87	88	89	91	93	95	98	100	103	106	109	113	116
	88	83	84	84	85	85	86	87	88	89	91	93	95	98	100	103	106	110	113	117	121
	89	84	84	85	85	86	87	88	89	91	93	95	97	100	103	106	110	113	117	122	
	90	84	85	86	86	87	88	89	91	92	95	97	100	103	106	109	113	117	122	127	
	91	85	86	87	87	88	89	90	92	94	97	99	102	105	109	113	117	122	126	132	
	92	86	87	88	88	89	90	92	94	96	99	101	105	108	112	116	121	126	131		
	93	87	88	89	89	90	92	93	95	98	101	104	107	111	116	120	125	130	136		
	94	87	89	90	90	91	93	95	97	100	103	106	110	114	119	124	129	135	141		
	95	88	89	91	91	93	94	96	99	102	105	109	113	118	123	128	134	140			
	96	89	90	92	93	94	96	98	101	104	108	112	116	121	126	132	138	145			
	97	90	91	93	94	95	97	100	103	106	110	114	119	125	130	136	143	150			
	98	91	92	94	95	97	99	102	105	109	113	117	123	128	134	141	148				
	99	92	93	95	96	98	101	104	107	111	115	120	126	132	138	145	153				
	100	93	94	96	97	100	102	106	109	114	118	124	129	136	143	150	158				
	101	93	95	97	99	101	104	108	112	116	121	127	133	140	147	155					
	102	94	96	98	100	103	106	110	114	119	124	130	137	144	152	160					
	103	95	97	99	101	104	108	112	116	122	127	134	141	148	157	165					
	104	96	98	100	103	106	110	114	119	124	131	137	145	153	161						
105	97	99	102	104	108	112	116	121	127	134	141	149	157	166							
106	98	100	103	106	109	114	119	124	130	137	145	153	162	172							
107	99	101	104	107	111	116	121	127	134	141	149	157	167								
108	100	102	105	109	113	118	123	130	137	144	153	162	172								
109	100	103	107	110	115	120	126	133	140	148	157	167	177								
110	101	104	108	112	117	122	129	136	143	152	161	171									
111	102	106	109	114	119	125	131	139	147	156	166	176									
112	104	107	111	115	121	127	134	142	150	160	170	181									
113	104	108	112	117	123	129	137	145	154	164	175										
114	105	109	113	119	125	132	140	148	158	168	179										
115	106	110	115	121	127	134	143	152	162	173	184										
116	107	111	116	122	129	137	146	155	166	177											
117	108	112	118	124	132	140	149	159	170	181											
118	108	113	119	126	134	142	152	162	174	186											
119	109	114	121	128	136	145	155	166	178												
120	110	116	122	130	138	148	158	170	182												
121	111	117	124	132	141	151	162	174	187												
122	111	118	125	134	143	154	165	178													
123	112	119	127	136	146	157	169	182													
124	113	120	129	138	148	160	172														
125	114	121	130	140	151	163	176														

Heat Index



Extreme Danger	Heat stroke likely.
Danger	Sunstroke, muscle cramps, and/or heat exhaustion likely. Heatstroke possible with prolonged exposure and/or physical activity.
Extreme Caution	Sunstroke, muscle cramps, and/or heat exhaustion possible with prolonged exposure and/or physical activity.
Caution	Fatigue possible with prolonged exposure and/or physical activity.

This chart is based upon shady, light wind conditions. Exposure to direct sunlight can increase the HI by up to 15°F. "+" indicates the heat index temperature is so great it is off the scale.

# SECTION VI: Eventing Appendices

---

## Appendix III: Chaperone and Emergency Contact Information

### Team Chaperones vs. Emergency Contacts

When competitors under the age of majority (minors) participate in a rally, there will be a designated "Official Team Chaperone." In the situation of scramble teams, the official team chaperone will be appointed by the rally officials and will be so noted in the rally program. The team chaperone serves as the team contact for rally and a responsible guiding presence to prepare the team for success. Competitors who are above the age of majority (adults) participating in a rally will not have a designated chaperone but must submit the name and contact information for their emergency contact.

### Team Chaperones

#### *Time Commitment*

The official team chaperone is responsible for team members during the hours of competition and on competition grounds only (from arrival on grounds until departing rally ground at beginning and end of each day of competition).

#### *Transportation, Driving and Lodging*

- Decisions to allow a competitor **that is a minor** to drive or not, who they can or cannot ride with, who they can or cannot have in a vehicle that they are driving, where they stay at night and with whom they stay, and who is to be responsible for a competitor are all decisions that must be made by the parent/legal guardian. These decisions are not a decision of USPC, their region, club/center, or the rally organizer. Specific arrangements must be made by and between the parent/legal guardian and the adult assuming any of these responsibilities in the absence of the parent/guardian.

#### *Preparing Your Team for Success*

- Initiate contact with all team members prior to leaving for the competition and gather cell phone numbers as appropriate. In cases of scramble team members, request contact information from the rally secretary. Share this information with team captain and/or stable manager.
- Encourage the team to have meetings prior to leaving for rally. Be sure all members of a scramble team are included in the decision-making process, either by email or phone contact, if a distance away.
- Discuss team equipment, review all rules that apply and any decisions regarding snacks, drinks, plans for meals, etc. Determine how the team members plan to provide snacks and drinks (i.e., each team member contribute a sum of money to a pot or each member is assigned specific items to bring). If each is contributing money, it must be collected before the rally. Be sure to know who is bringing cooler(s), as to avoid a trip to the local store.

- Plan arrival time at the competition site and any details such as arrangements for ordering bedding, if needed, and who is assigned to do this (again collect money in advance if needed).
- On the first day of the rally, gather the team together before they separate for the night and make plans for the next day. Include a review of their competition schedule and how they can best work together to help each other prepare.
- Determine a regular meeting place and de-brief the team at the end of each day of competition. Take this opportunity to offer words of praise, acknowledge their accomplishments, and encourage the sense of teamwork and team building. Guide the team towards constructive criticism and steer them away from finger pointing. Have the team make plans for the next day concerning time they will arrive on the competition grounds, who will feed mounts the next morning, who will re-supply the tack room cooler with ice, drinks and snacks (get requests for drinks/snacks) and make the plans for lunch. Be sure any plans for cooler and/or lunch delivery follow any requirements as stated in the competition entry and they understand the plan. Have the team leave with a plan for the next day in place before they go off for an evening of relaxation.

### Emergency Contacts

Anyone listed as an emergency contact for a competitor should be reachable by phone for the duration of the competition. Emergency contacts do not need to be on the competition grounds, but ideally are also within driving distance of the competition in the case of an emergency.

# SECTION VI: Eventing Appendices

---

## Appendix III: Chaperone Form

*To be completed by the chaperone and turned in with the rally entry for USPC members below the age of majority.*

### Chaperone duties shall include:

1. The primary function of the "Official Team Chaperone" is to ensure that there is a contact person for every USPC member below the age of majority, on the grounds for the duration of the competition.
2. While multiple Chaperone Forms may be turned in for a single team, only one person will be designated the Official Team Chaperone. If the Official Team Chaperone must leave the grounds during the competition, they must delegate the team chaperone duties to another responsible adult, making it clear that they are to respond to rally officials and any team members in your absence.
3. Be present and available to rally officials and all team members for the duration of the competition.
4. Being in contact with parents/guardians for all team members during competition hours.
5. Being in contact with all team members and their parents/ guardians outside of competition hours.
6. Have copy of and be familiar with the current discipline rulebook and the current Horse Management Handbook. Rulebooks available for download from [www.ponyclub.org](http://www.ponyclub.org).
7. Be aware that USPC members are required to wear a current, up to date USPC medical card/bracelet on their arm at all USPC activities.
8. Be familiar with the effects of heat and humidity and the potential risk for heat related illness. Take an active role in helping to keep all team members well hydrated and take every opportunity to encourage water breaks.
9. Uphold USPC Substances and Weapons Policy which prohibits the inappropriate or illegal use of any substance, including but not limited to drugs or alcohol, by anyone participating in any manner. Weapons of any kind are forbidden. Refer to About/About the Organization/By-Laws, Policies and Resolutions on [www.ponyclub.org](http://www.ponyclub.org) for the full policy statement.
10. Remember that administration of medications is the sole responsibility of the parent/guardian.

I have read and understand the duties of a chaperone as listed above.

Chaperone for the following team or individual(s)

-----

-----

-----

Name of Chaperone: \_\_\_\_\_

Signature: \_\_\_\_\_

Cell Phone Number: \_\_\_\_\_

Date: \_\_\_\_\_

# SECTION VI: Eventing Appendices

---

## Appendix III: Emergency Contact Form

*for USPC Members Above the Age of Majority*

The age of majority is the threshold of adulthood in law. As USPC members above the age of majority are adults in the eyes of the law and therefore responsible for themselves; USPC does not require a "chaperone" for these members at competitions. USPC does require that members above the age of majority submit Emergency Contact information for each competition. Age of majority varies per state.

USPC Member: \_\_\_\_\_ Current Age: \_\_\_\_\_ State of Residence: \_\_\_\_\_

Competition Name: \_\_\_\_\_ Competition Date: \_\_\_\_\_

Emergency Contact Name: \_\_\_\_\_

Emergency Contact Relationship to Competitor: \_\_\_\_\_

Emergency Contact Home Phone Number: \_\_\_\_\_

Emergency Contact Cell Phone Number: \_\_\_\_\_

*An additional Emergency Contact can be included, but is not required.*

Secondary Emergency Contact Name: \_\_\_\_\_

Secondary Emergency Contact Relationship to Competitor: \_\_\_\_\_

Secondary Emergency Contact Home Phone Number: \_\_\_\_\_

Secondary Emergency Contact Cell Phone Number: \_\_\_\_\_

# Section VI: Eventing Appendices

---

## Appendix IV: Junior/Senior Team Formation

### PERMISSION FOR JUNIOR COMPETITORS TO PARTICIPATE IN A RALLY ON A TEAM WITH SENIOR COMPETITORS

When merging a member under the age of 18 on a team with member(s) 18 years of age or older, written permission should be obtained by the person configuring the team. This form can be used for written permission, but other methods (email, etc.) are also acceptable. Written permission should be maintained with the rally entry paperwork.

This agreement acknowledges that \_\_\_\_\_ and their parent(s)/legal guardian(s) agree to  
*(Name of Participant)*  
the participant's placement onto a rally team with:

\_\_\_\_\_ *(Name of Senior Participant)* \_\_\_\_\_ *(Name of Senior Participant)*

\_\_\_\_\_ *(Name of Senior Participant)* \_\_\_\_\_ *(Name of Senior Participant)*

at \_\_\_\_\_ rally.  
*(name of rally)*

PARTICIPANT NAME *(Print)*: \_\_\_\_\_ DATE OF BIRTH: \_\_\_\_\_

PARTICIPANT SIGNATURE: \_\_\_\_\_ DATE: \_\_\_\_\_

PARENT/GUARDIAN NAME *(Print)*: \_\_\_\_\_

PARENT/GUARDIAN SIGNATURE: \_\_\_\_\_ DATE: \_\_\_\_\_

\*PARENT/GUARDIAN NAME *(Print)*: \_\_\_\_\_

\*PARENT/GUARDIAN SIGNATURE: \_\_\_\_\_ DATE: \_\_\_\_\_

Note: Combining junior and senior teams into one division is not the same as combining junior and senior members onto one team. Junior competitors can always compete up a division as a senior to fill out a team. Senior competitors can never compete down to a junior division. Before combining junior and senior aged competitors on the same team, rally organizers must obtain the permission of the junior competitor and their parent(s)/legal guardian(s).

\*Second parent/guardian signature if applicable.

# SECTION VI: Eventing Appendices

## Appendix V: USPC Eventing Rally TD's Report

(This form is also available electronically on the Rulebooks page of the USPC website.)

\*=information required; circle yes or no when you see **(yes/no)**.

TD/Steward's Name \* \_\_\_\_\_ Phone \* \_\_\_\_\_

TD/Steward's Email Address \* \_\_\_\_\_

TD/Steward's License number and affiliation \_\_\_\_\_

Organizer's Name \* \_\_\_\_\_ Phone \* \_\_\_\_\_

Organizer's Email Address \* \_\_\_\_\_

CHMJ Name\* \_\_\_\_\_ Phone \* \_\_\_\_\_

CHMJ Email Address \* \_\_\_\_\_ Number of AHMJ's\* \_\_\_\_\_

### Rally Information

Region \* \_\_\_\_\_ Rally Start Date \* \_\_\_\_\_ Rally End Date \*

Rally locations (please include all if multiple) \_\_\_\_\_

Is this a standard rally? \* \_\_\_\_\_

Did you have a CURRENT copy of the discipline rulebook? \* **(yes/no)**

Did you read the rulebook prior to attending the rally? \* **(yes/no)**

Was the entire rally conducted according to these rules? \* **(yes/no)**

Did Horse Management function according to the rules? \* **(yes/no)**

Did you have any problem with a stated rule? \* **(yes/no)** If yes, please tell us why. \_\_\_\_\_

Did you have a situation for which there was not a stated rule? \* **(yes/no)** If yes, please describe the situation. \_\_\_\_\_

Did any competitors receive Yellow Cards given during the rally? **(yes/no)** If yes, how many and why. \_\_\_\_\_

Were any competitors disqualified during the rally? \* **(yes/no)** If so, please tell us who and why. \_\_\_\_\_



# SECTION VI: Eventing Appendices

---

Was the rally well-organized? **(yes/no)** Please describe. \_\_\_\_\_  
\_\_\_\_\_  
\_\_\_\_\_

Were the facilities suitable for all phases of the rally? **(yes/no)** If no, please describe areas of concern. \_\_\_\_\_  
\_\_\_\_\_  
\_\_\_\_\_

Were the organizers and other officials friendly and supportive to competitors and each other? \* **(yes/no)**

Was sufficient personnel provided to manage all phases? \* **(yes/no)**

Were medical personnel & equipment (EMT, ambulance) on the grounds during mounted activities and on call at all times? \* **(yes/no)**

Were any accident reports filed? \* **(yes/no)**

For the duration of the rally, was safety placed as a priority? **(yes/no)** Please describe. \_\_\_\_\_  
\_\_\_\_\_  
\_\_\_\_\_

Were the communications suitable for all phases of the rally? **(yes/no)** If no, please describe areas of concern. \_\_\_\_\_  
\_\_\_\_\_  
\_\_\_\_\_

Were briefings held? **(yes/no)** Please describe. \_\_\_\_\_  
\_\_\_\_\_  
\_\_\_\_\_

Was the rally a learning experience for all competitors? \* **(yes/no)** Please describe. \_\_\_\_\_  
\_\_\_\_\_  
\_\_\_\_\_

Do you feel you were given all the materials to do your job effectively? \* **(yes/no)** If no, please describe why not. \_\_\_\_\_  
\_\_\_\_\_  
\_\_\_\_\_

## Horse Management Review

As the TD/steward, you are charged with the first level of reviewing the decisions in Horse Management. Under the rules of competition, the initial protest from the decision of the CHMJ is to the TD/steward. A protest can only be made by the team or individual competitor against whom an adverse decision is made. Therefore if a protest comes to you to reconsider the decision of the CHMJ and you do NOT sustain the decision of the judge, the protest is concluded. If you do sustain the CHMJ, then a protest can be placed before the discipline ground jury.

Were all inquiries/protests that were brought to you as TD/steward in written form on the official form?\* **(yes/no)**

Do you have any comments on the Horse Management competition at this rally? \_\_\_\_\_  
\_\_\_\_\_  
\_\_\_\_\_

Do you have any additional comments or thought you would like to share? \_\_\_\_\_  
\_\_\_\_\_

# SECTION VI: Eventing Appendices

## Rally Competitor Numbers

Please utilize the lines below to indicate what competition divisions were offered and the number of teams and competitors in each.

	Level/ Division*	Number of Teams*	Number of Competitors*	Number of Competitors with D-2 Certification above 10 years of age*	Number of Competitors with C-1 Certification above 12 years of age*
Junior Greenie	_____	_____	_____	_____	_____
Senior Greenie	_____	_____	_____	_____	_____
Junior Starter	_____	_____	_____	_____	_____
Senior Starter	_____	_____	_____	_____	_____
Junior Beginner Novice	_____	_____	_____	_____	_____
Senior Beginner Novice	_____	_____	_____	_____	_____
Junior Training	_____	_____	_____	_____	_____
Senior Training	_____	_____	_____	_____	_____
Junior Modified	_____	_____	_____	_____	_____
Senior Modified	_____	_____	_____	_____	_____
Other (please specify)	_____	_____	_____	_____	_____

President of the Ground Jury's Name\* \_\_\_\_\_ Phone\* \_\_\_\_\_

President of the Ground Jury's Email Address\* \_\_\_\_\_

President of the Ground Jury's License number and affiliation \_\_\_\_\_

Judge's Name\* \_\_\_\_\_ Phone\* \_\_\_\_\_

Judge's Email Address\* \_\_\_\_\_

Judge's License number and affiliation \_\_\_\_\_

Judge's Name\* \_\_\_\_\_ Phone\* \_\_\_\_\_

Judge's Email Address\* \_\_\_\_\_

Judge's License number and affiliation \_\_\_\_\_

Please email to [events@ponyclub.org](mailto:events@ponyclub.org) or mail to  
Activities Department • United States Pony Clubs • 4041 Iron Works Parkway • Lexington, KY 40511  
859.254.7669 • Fax 859.223.4652 • [www.ponyclub.org](http://www.ponyclub.org)

# SECTION VI: Eventing Appendices

## Appendix VI: Eventing Coaching Guidelines Form

Each coach should have a copy and a signed copy submitted with entries. Photocopy as necessary.

Penalties for violating these coaching guidelines will be assessed by the discipline ground jury and/or overall ground jury under the rules governing unauthorized assistance. Any coach not adhering to the rules set forth below may be removed from their position for the duration of the phase and/or competition.

Coaches are recommended for Eventing rallies and Championships. There may be one or more coaches per team; the organizer or ring steward may limit the number of coaches in a warm-up area at any given time.

### Agreement

By signing this form, you:

- Agree to be familiar with and observe all USPC By-Laws, Policies and competition rules.
- Agree to be governed by Horse Management guidelines as expected of competitors, including appropriate attire, footwear and conduct.
- Agree to adhere to the USPC Conflict of Interest and Code of Ethics Policies in all your actions and decisions.
- Agree to conduct yourself in a fair and courteous manner.

### Coaches Must

- Check in as requested and attend any official coaches' briefings.
- Be familiar with, understand and comply with the current USPC discipline and Horse Management rules.
- Be aware of the welfare of mount and rider.
- Wear identification as provided by the organizer/secretary during the competition times.
- Follow all discipline coach parameters outlined in the discipline rulebook.
- Assist competitors in learning and understanding all rules pertinent to the competition.
- Help any Pony Club competitor who asks for help or who is present without a coach.

### All phase coaches must sign that they have read this sheet:

I \_\_\_\_\_ have read and agree to follow the USPC Eventing Rulebook and above guidelines for coaching.

Printed Name: \_\_\_\_\_ Signature: \_\_\_\_\_

Date: \_\_\_\_\_ Cell Phone: \_\_\_\_\_ Email: \_\_\_\_\_

Please list the competitors/teams you are coaching:

1. \_\_\_\_\_
2. \_\_\_\_\_
3. \_\_\_\_\_
3. \_\_\_\_\_
4. \_\_\_\_\_
4. \_\_\_\_\_
5. \_\_\_\_\_
6. \_\_\_\_\_

### Coaches Must Not

- Enter the barn except during authorized visiting times.
- Interfere with the immediate care of the mount under penalty of elimination of the competitor.
- Coach in a manner that interferes with the warm-up of other competitors.
- Be the organizer, and member of the organizing committee or any other official of the competition.
- Be a team chaperone.
- Be a RS at a regional competition.

### Coaching Duties

- Warming-up competitors for competition in the designated warm-up areas only.
- In addition, a coach may lead a competitor's mount into the arena area.
- Coaches may observe but not participate in (unless requested), soundness checks or horse inspections.
- Meet with the team to discuss ride times, planning and how to best utilize the coach within the team.

### Communications between Coaches and Competitors

- Coaches may communicate with the competitors during the official briefing and any subsequent briefings as required by the organizer and in the warm-up area prior to and following the competitor's ride.
- Coaches may accompany competitors during their ride, arena inspection, course walks or any other subsequent times competition areas are open for warm-up, during which they may give advice and coach.

### Competitors who wish to Coach while Competing

Championships competitors who are 18 years of age as of January 1 of the competition year may coach other members recognizing that:

- No scheduling changes will be made to accommodate coaching /riding times.
- Care of mount and other competitor responsibilities take precedence over coaching.

# SECTION VI: Eventing Appendices

---

## Appendix VII: Eventing Yellow (Warning) Card

UNITED STATES PONY CLUBS

A yellow warning card may be issued by a rally official at a USPC competition to any competitor, spectator or participant for improper conduct, or for noncompliance with the rules. If the offence is considered egregious, the discipline ground jury may decide to assess penalty points to accompany the Yellow Card as outlined in Article 21 and 61.

Important information to know about the issuance of a Warning (Yellow) Card:

1. A Yellow Card is a warning with possible attached penalty points given for any infraction that is a disqualifiable offense.
2. A Yellow Card may be, but is not required to be given before the disqualification of a competitor or team.
3. A Yellow Card that incurs penalty points that will be recorded in the "Other" column of the scoresheet.
4. There is no appeal against receiving a Yellow Card.
5. A copy of any Yellow Card issued must be sent to the Activities Department, [events@ponyclub.org](mailto:events@ponyclub.org).

Issued to: (Name) \_\_\_\_\_ Competitor # \_\_\_\_\_

Region/Club/Center: \_\_\_\_\_

Address: \_\_\_\_\_

City/State/Zip: \_\_\_\_\_

At the following competition: \_\_\_\_\_

Date/Time of incident: \_\_\_\_\_

Description of incident: \_\_\_\_\_

\_\_\_\_\_

\_\_\_\_\_

\_\_\_\_\_

\_\_\_\_\_

\_\_\_\_\_

\_\_\_\_\_

\_\_\_\_\_

\_\_\_\_\_

*(please use back of page if necessary)*

Issuing Official: (print) \_\_\_\_\_ Position: \_\_\_\_\_

Signature: \_\_\_\_\_ Date: \_\_\_\_\_

Phone: \_\_\_\_\_ Email: \_\_\_\_\_

Please email to [events@ponyclub.org](mailto:events@ponyclub.org) or mail to  
Activities Department • United States Pony Clubs • 4041 Iron Works Parkway • Lexington, KY 40511  
859.254.7669 • Fax 859.223.4652 • [www.ponyclub.org](http://www.ponyclub.org)

# SECTION VI: Eventing Appendices

## Appendix VIII: Specifications for Horse Trials

*For other specifications, such as depth of water, widths of water crossings, etc., see USEF Rules EV 140.*

DRESSAGE	BEGINNER NOVICE	NOVICE	TRAINING	MODIFIED
<b>U.S. Equestrian Federation Eventing Tests</b>	Beg. Novice A, B	Novice A, B	Training A, B	Modified A, B
<b>CROSS-COUNTRY</b>				
<b>Distances</b>	1400-2000 m	1600-2200 m	2000-2600 m	2200-3000 m
<b>Speeds/Optimum Time</b>	300-350 mpm	350-400 mpm	420-470 mpm	490 mpm
<b>Speed/Speed Faults</b>	420 mpm	450 mpm	520 mpm	N/A
<b>Efforts</b>	14-18	16-20	20-24	22-28
<b>HEIGHTS:</b>				
<b>Fixed</b>	0.79 m (2'7")	0.90 m (2'11")	1.00 m (3'3")	1.05 m (3'5")
<b>Brush</b>	0.91 m (3')	1.10 m (3'7")	1.20 m (3'11")	1.25 m (4'1")
<b>SPREADS:</b>				
<b>Highest Point</b>	.084 m (2'9")	1.00 m (3'3")	1.20 m (3'11")	1.30 m (4'3")
<b>Base</b>	1.22 m (4")	1.50 m (4'11")	1.80 m (5'11")	2.04 m (6'5")
<b>Without Height</b>	1.22 m (4')	2.00 m (6'7")	2.40 m (7'11")	2.60 m (8'6")
<b>DROPS:</b>	1.00 m (3'3")	1.20 m (3'11")	1.40 m (4'7")	1.50 m (4'11")
<b>JUMPING</b>				
<b>Lengths</b>	Maximum 600 m	Maximum 600 m	Maximum 600 m	Maximum 600 m
<b>Speeds</b>	300 mpm	320 mpm	325 mpm	325 mpm
<b>Efforts</b>	9-11	9-11	10-12	10-13
<b>Heights</b>	0.79 m (2'7")	0.9 m (2'11")	1.00m (3'3")	1.10 m (3'7")
<b>SPREADS:</b>				
<b>Overall Spread:</b>				
<b>Oxers</b>	1.0 m (3'3")	1.1 m (3'7")	1.2 m (3'11")	1.25 (4'1")
<b>Triple Bar</b>	1.2m (3'11")	1.3 m (4'3")	1.4 m (4'7")	1.45 (4'9")

# SECTION VI: Eventing Appendices

---

## Appendix IX: Dressage Saddlery: Permitted Bits

Note: Final determination of permitted and prohibited bits and saddlery may require referencing Annex 1 on the USEF website for the most up-to-date information. Any of the rings or cheeks shown on these illustrations are permitted with any of the mouthpieces for National Eventing Competitions.

\*Photos and illustrations courtesy of the FEI

### 1. Action of Bits

- A. Snaffle bits work on the corners, tongue and bars of the mouth depending on their shape and the rein effect produced by the Athlete
- B. Single joined bits may also work on the roof of the mouth if not fitted and used correctly
- C. Straight bar snaffles cause more tongue pressure
- D. Double jointed snaffles conform to the shape of the mouth and tongue creating more event pressure
- E. Rounded or moving centerpieces encourage movement of the tongue and salivation
- F. Curved mouthpieces with joints and Mullen mouth bits conform to the shape of the tongue and mouth.

### Cheek Pieces

- A. Full cheek, egg butt and D ring snaffles are more stable and also work on the sides of the mouth
- B. Loose ring snaffles have a more moveable mouthpiece to encourage mouthing of the bit and salivation
- C. Hanging cheek snaffles have a slight leverage action and work more on the corners of the mouth and poll

### 2. Material:

- A. Durable enough to be safe
- B. Must keep smooth and solid surface, not to be altered by the chewing of the horse in order to prevent horse from injuries
- C. Not health-damaging
- D. Snaffles: can be made of metal, flexible rubber or synthetic, or plastic or leather material
- E. Bridoon and curb: must be made of metal and/or rigid plastic and may be covered with rubber/latex.















### 3. Permitted Snaffles (see diagrams)

- A. May have one or two joints
- B. May be double-jointed with rounded or rotating mouthpiece allowing for better fit and comfort.
- C. May have a slightly curved port, allowing more room for the tongue. The maximum height is 30mm from the lower part of the side of the tongue to the highest point of the deviation.
- D. Wavy bits are allowed.
- E. A bushing or coupling is permitted as the center link and must be solid with no moveable parts other than a roller.
- F. The center link must be smooth and rounded
- G. The diameter of the mouthpiece must be a minimum of 10mm at the rings or cheeks.

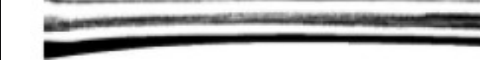
### 4. Illegal Bits







- A. Any single or double jointed cable bits (may cause pinching of the tongue or cheeks)
- B. Bits which place mechanical restraint on tongue (large immovable center link causes excessive pressure on tongue)

# SECTION VI: Eventing Appendices

Bits	
Permitted Mouthpieces - any approved mouthpiece may be combined with any approved cheekpiece	
	Single-Jointed
	Double-Jointed
	Shaped Single-Jointed
	Single-Jointed with Rubber Coating
	Double-Jointed with Rotating Middle-Piece
	Double-Jointed with Plastic Middle-Piece
	Ball-Jointed
	Multiple Ball-Jointed
	Shaped Double-Jointed
	
	
	
	
	
	











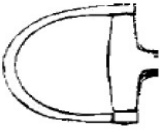

# SECTION VI: Eventing Appendices

---

Bits	
<b>Permitted Mouthpieces (continued) - any approved mouthpiece may be combined with any approved cheekpiece</b>	
	
	
	
	Dr. Bristol
	French Link
	Happy Mouth



# SECTION VI: Eventing Appendices

Bits	
Permitted Cheekpieces - any approved mouthpiece may be combined with any approved cheekpiece	
	Loose Ring
 	Egg-Butt
 	D-Ring
 	D-Ring
 	Hanging Cheek
	Loose Ring with Sleeves
 	Snaffle with Full Cheeks
	Traditional Snaffle Cheek Piece

# SECTION VI: Eventing Appendices

## Appendix X: Permitted Nosebands

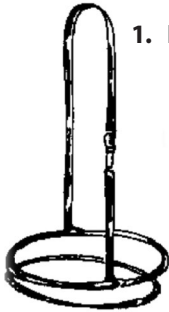

1. Flash Noseband

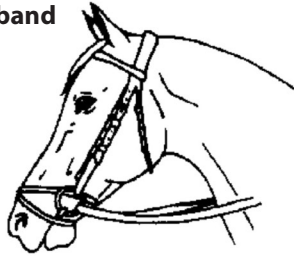

5. Double Bridle with Cavesson Noseband

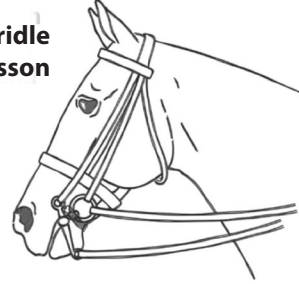

2. Drop Noseband

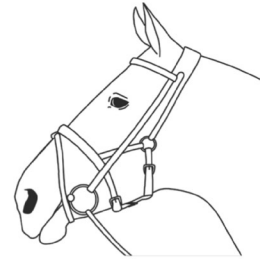
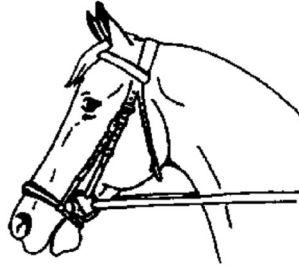

3. Mexican (crossed) Noseband

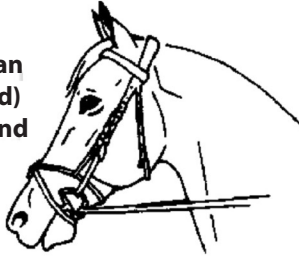

6. Combined Noseband

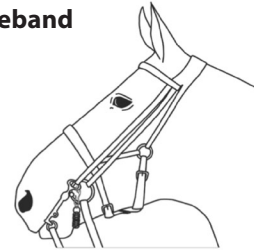

4. Cavesson Noseband

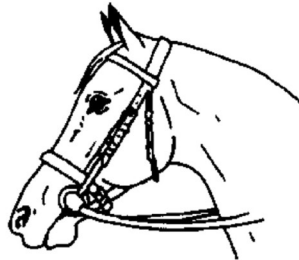

7. Micklem Bridle

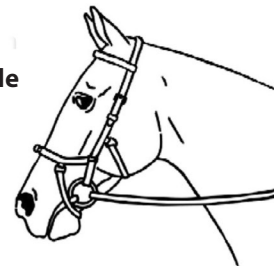

8. Stubben Snaffle Bridle 2500 Freedom Stubben S

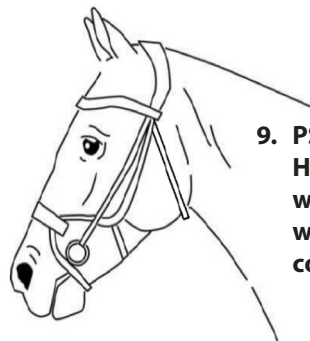

9. PS of Sweden High Jump Bridle with throat latch, without elastic connections to bit



10. PS of Sweden Jump Off Bridle with throat latch, without elastic connections to bit

# SECTION VI: Appendices

## Appendix XI: Dressage Arenas

**Standard Arena**  
 (20M X 60M)  
 Diagonal Length:  
 63.25m = 207'6"

**Small Arena**  
 (20M X 40M)  
 Diagonal Length:  
 44.72m = 146'9"

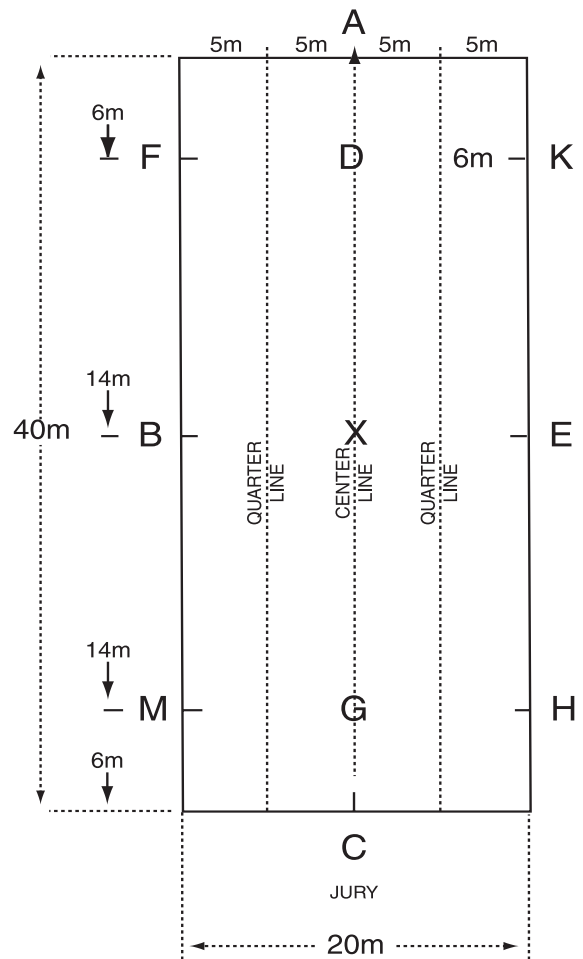
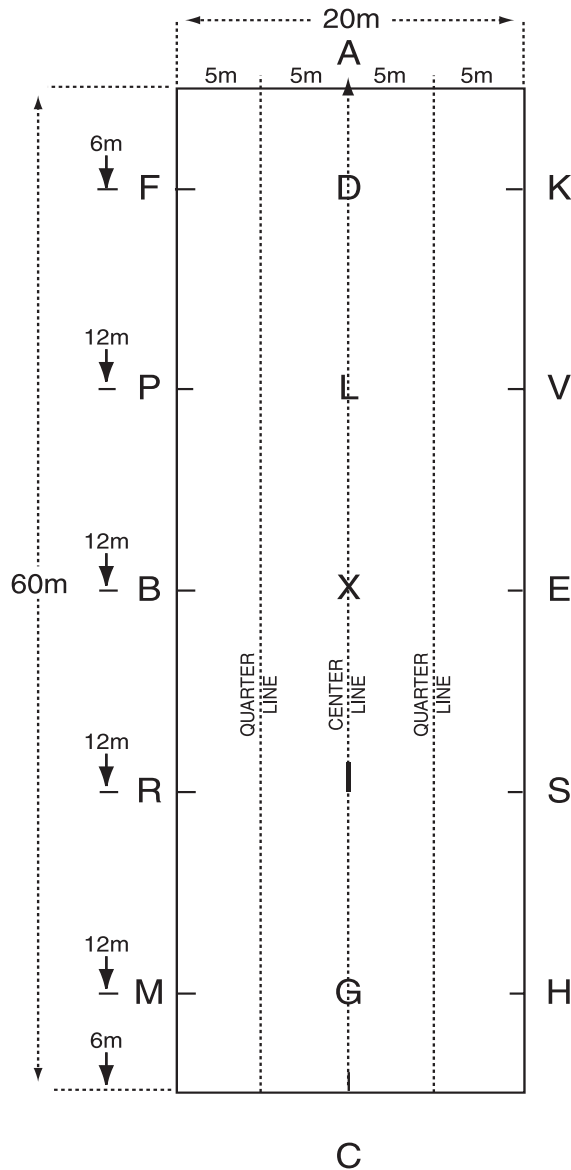

**See the Dressage section of the Rally Organizers Guide for information on setting up Dressage Arenas.**

# SECTION VI: Eventing Appendices

## Appendix XII: Examples of Obstacles Composed of Several Elements

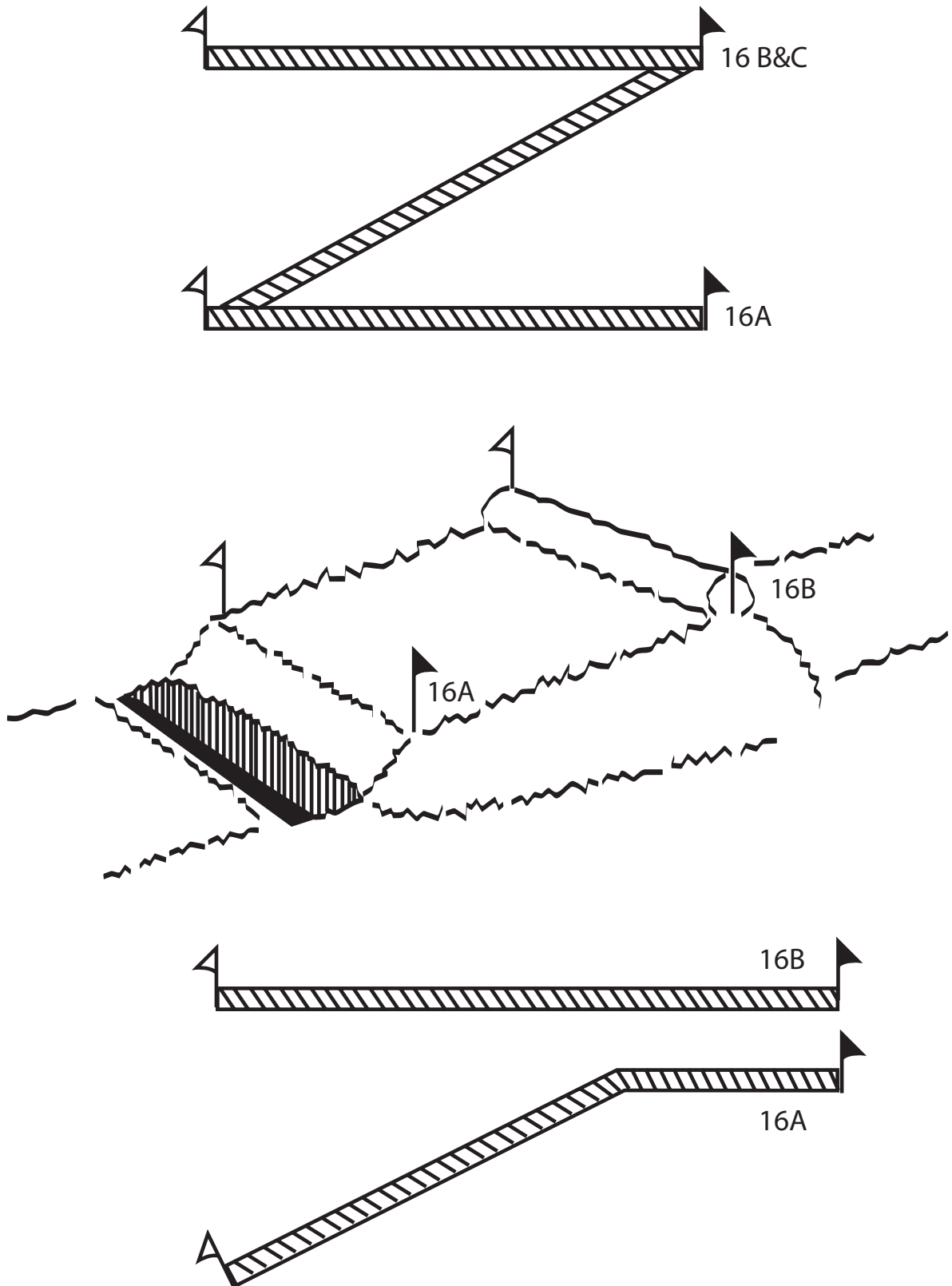

# SECTION VI: Eventing Appendices

## Appendix XIII: Examples of Run-Outs and Circles

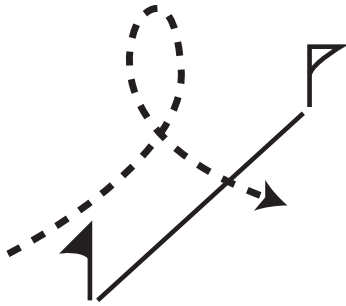

Not presented initially  
(0 penalties)

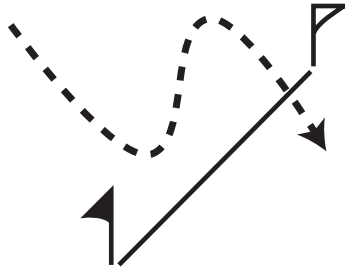

Run-out  
(20 penalties)

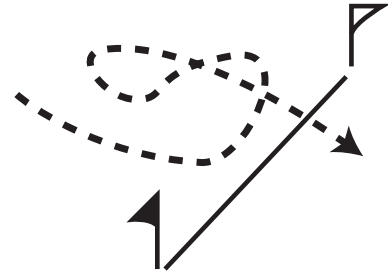

Run-out  
(20 penalties)

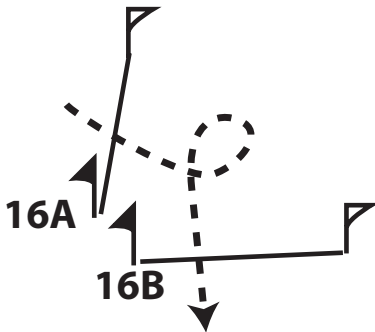

Circle  
(20 penalties)

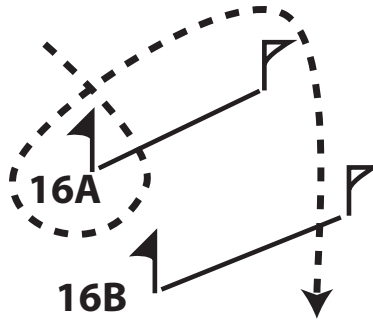

Circle  
(20 penalties)

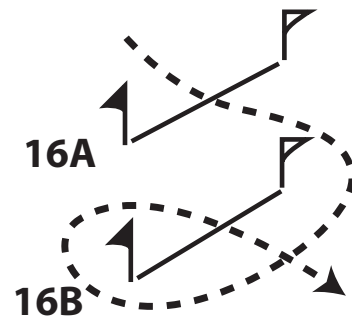

Circle  
(20 penalties)

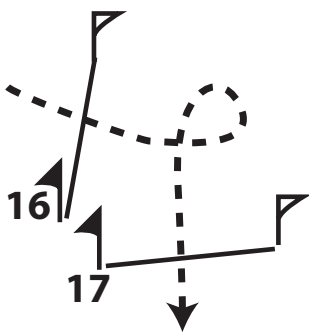

Not presented initially  
(0 penalties)

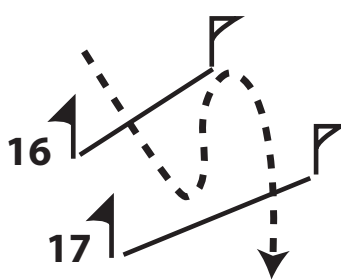

Run-out  
(20 penalties)

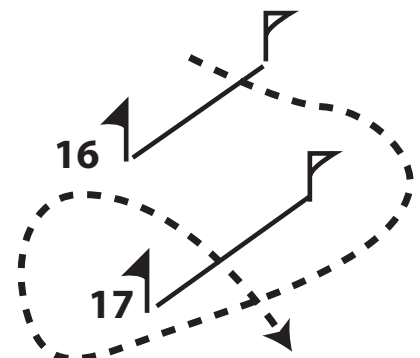

Not presented at 17  
(0 penalties)